



Technical & Specification Information

Bosch 32 Series Water Heaters

**Bosch Commercial Series Condensing & Non-Condensing
Continuous Flow Water Heaters**



BOSCH

Hot Water & Heating



Bosch and you, making a difference

As part of the Bosch Group, Bosch Thermotechnology products are designed and manufactured to provide customers with the highest levels of quality and reliability which are synonymous with the Bosch name throughout the world.

Bosch Thermotechnology has the resources and support capability to offer you the value-added solutions you deserve. Bosch Thermotechnology has established a nationwide network of Service Engineers and trained Field Sales Managers supported by an experienced technical team which is able to provide support and advice from system layout through to installation.

Bosch Thermotechnology is dedicated to providing high performance, energy efficient hot water systems for a wide range of installations, including large domestic properties and commercial applications such as offices, schools, sports centre's and hotels.

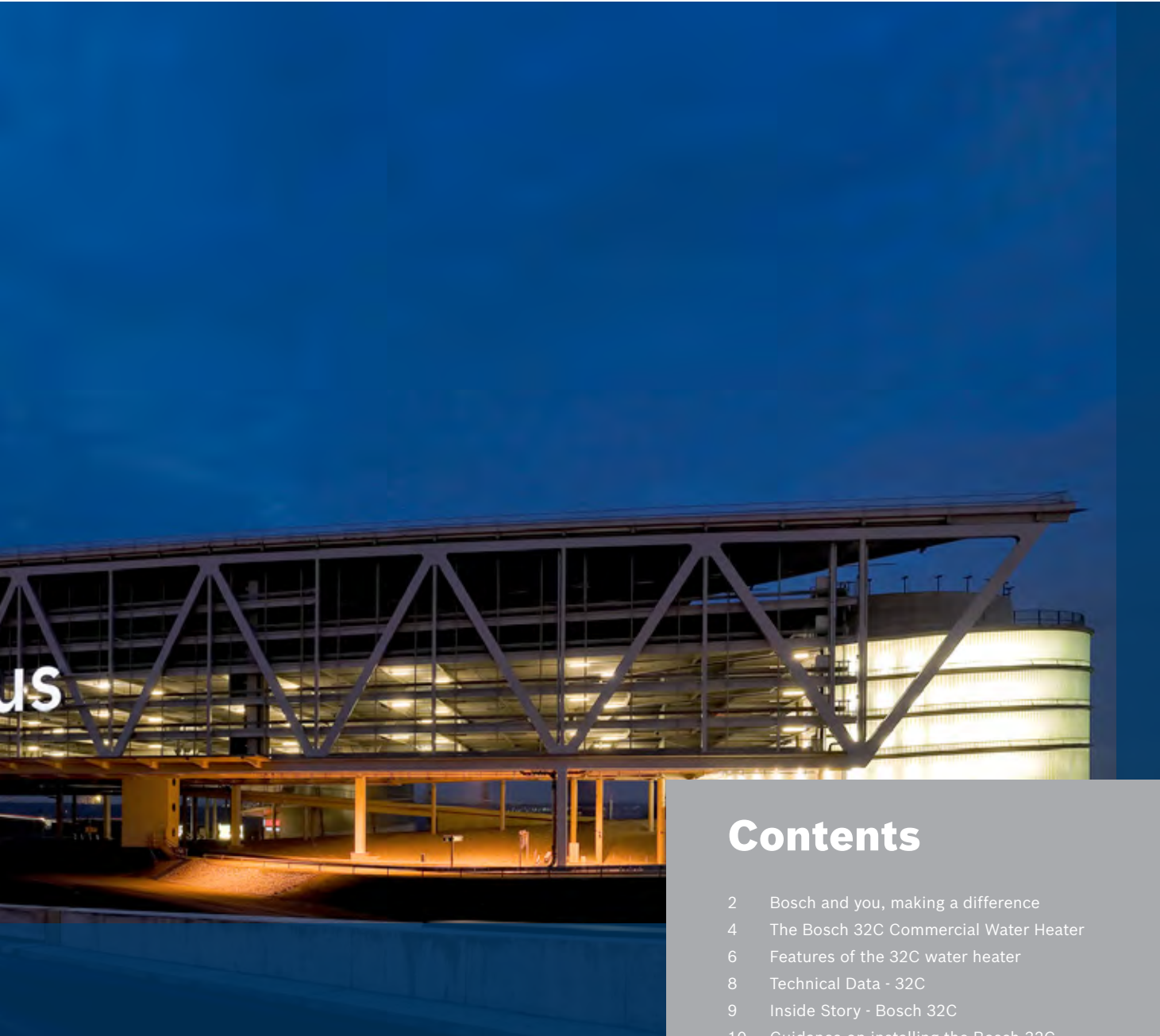

The Bosch Thermotechnology Division is a leading global supplier of innovative and energy efficient Hot water, Heating and VAC solutions for commercial and industrial applications. Our products are designed and manufactured to the highest quality standards. Ongoing investment allows us to bring new technologies to market, as well enhance existing products.

In this respect, our customers benefit from Bosch solutions that are both highly efficient and reliable.

Mark Blacker

General Manager

Bosch Thermotechnology Division,
Australia, New Zealand & Oceania

Contents

- 2 Bosch and you, making a difference
- 4 The Bosch 32C Commercial Water Heater
- 6 Features of the 32C water heater
- 8 Technical Data - 32C
- 9 Inside Story - Bosch 32C
- 10 Guidance on installing the Bosch 32C
- 14 Flueing configurations - 32C
- 17 The Bosch 32 & 32Q Commercial water heaters
- 18 Features of the Bosch 32
- 20 Features of the Bosch 32Q
- 21 Technical Data - 32 & 32Q
- 22 Inside Story - Bosch 32
- 23 Inside Story - Bosch 32Q
- 24 Guidance on installing the 32 & 32Q
- 28 Flueing configurations - 32 & 32Q
- 29 System Layouts
- 32 Bosch Commercial 32 Series Accessories
- 36 Commercial Tanks
- 38 Cascade Systems
- 39 Technical Data - CascadeFlow Systems
- 49 Sizing Guide - CascadeFlow Systems
- 50 Tank Systems - Single Appliance Pack
- 52 Cascade & Tank Systems
- 55 Sizing Guide - CascadeTherm Systems
- 56 Part Numbers - Bosch 32 Series and Accessories
- 59 Warranty Page



The **Bosch 32C** Commercial continuous flow water heater

Global responsibility for nature and the environment

Bosch Thermotechnology is committed to environmental protection. Product development is being prioritised in the interests of peoples well being, the economical use of resources and environmental sustainability.

In just a few short years, Australia's domestic heating and hot water industry has changed dramatically.

Words and expressions such as "renewable energy", "sustainable technology" and "carbon footprint" have become a part of everyday conversation and have been fuelled by extreme weather and stark television images.

Bosch Thermotechnology, while not continuing to satisfy the daily demands for heating and hot water comfort, has taken a lead in developing solutions which reduce the impact on the environment by reducing CO2 emissions – not only for today but well into the future.

With this in mind Bosch is proud to offer a high efficiency, high output gas-fired condensing continuous flow water heater for use with renewable energy sources or traditional fuels.

With an output of up to 57.5kW, Bosch 32 Series water heaters are ideal for use in high end residential, and both small and large commercial applications. It offers high energy-efficient condensing operation and up to 6 appliances can be cascaded in parallel offering a combined flow rate of up to 192 L/min.



The Bosch water heater at a glance

| | Bosch 32C |
|---------------------|----------------------|
| Part No NG | BC3200RANG |
| Part No LPG | BC3200RALP |
| Output (kW) Max | 57.5 kW |
| Input (mj) Max | 217 |
| Input (mj) Min | 11 |
| Flow rate at 50°C | 16L/min |
| Flow rate at 25°C | 32L/min |
| Install Application | Internal or External |
| Available Gas Types | Natural & LP Gas |
| Star Rating | 6.0 |
| Efficiency | 94% |

The Bosch 32C water Heaters features and benefits

| Features | Benefits |
|--|---|
| Continuous flow hot water heater | On demand and sustained delivery |
| Condensing technology | High efficiency |
| Natural gas and LPG models | Fuel flexibility |
| Up to 3 temperatures controllers | Remote temperature control, service and maintenance assistance |
| Water temperature adjustment connector | Ability to adjust to multiple temperature settings without controller |
| Direct integration with solar heating | Adaptable to ecologically sustainable design requirements |
| Accessory to control manifold of up to 6 appliances | Maximises output up to 192 l/min at a 25 deg. temperature rise |
| Internal/External installation | Installation flexibility |

The features of the 32C commercial water heater

Energy saving condensing design

The use of a condensing appliance contributes to achieving higher efficiency by incorporating a secondary heat exchanger. Heat within the flue gases is used to preheat the inlet water, and so recaptures energy that would otherwise be lost.

Applications

The Bosch 32C water heater has been optimised for use in domestic and commercial applications where there are high demands for domestic hot water (DHW).

At 57.5kW heating output, the Bosch 32C water heater offers the following performance:

- ▶ Up to 16 litres per minute with 50°C rise
- ▶ Up to 32 litres per minute with 25°C rise

The Bosch 32C water heater can be used with Natural Gas (NG) or Liquid Petroleum Gas (LPG) and can be installed in single appliances or multiples of up to 6 appliances. Extended flue lengths of up to 13m are also possible, helping to provide even greater design flexibility.

Large Domestic

A commercial condensing water heater is ideal for larger applications where:

- ▶ There is increased demand for domestic hot water (DHW) – e.g. Multiple fixtures such as sinks and showers
- ▶ Pre-heated water supply is to be used – e.g. by solar thermal

Typical examples include larger homes and small hotels.

Light commercial/non-domestic

Ideal for light commercial or non-domestic applications with:

- ▶ High demands for DHW – e.g. multiple fixtures such as sinks and showers
- ▶ Where demands for DHW are consistent throughout the day



Commercial

Suitable for large commercial applications where there is:

- ▶ Consistent high demands for DHW – e.g. laundries, hospitals
- ▶ Very high cyclic demands for DHW – e.g. hotels, schools

Bosch 32C's ability to use water pre-heated by renewable heat sources supports planning and investment requirements.

Such applications can take full advantage of the cascade controls that are part of the Bosch 32C offering. These controls provide the ability to deliver up to 192 litres per minute of hot water on demand at a 25°C rise.

Certain commercial applications may also take advantage of the ability to provide a hot water temperature of up to 85°C for sterilisation processes and secondary circulation.

Key benefits to the end user

Key benefits to the use

High volumes of hot water

- ▶ Multiple showers, sinks and baths used concurrently.

Energy savings

- ▶ Condensing technology for greater energy efficiency
- ▶ 6 Star energy efficiency rating - One of the most efficient commercial appliances on the market at 94% efficiency rating
- ▶ Compact size and modular design makes for easy retrofit installation

Low environmental impact

- ▶ Condensing design allows for a lower environmental impact
- ▶ Solar compatible system suitable for use with pre-heated water from renewables
- ▶ Compatible with hot water secondary circulation to reduce water wastage

Key benefits for installers

- ▶ Flexible design options
- ▶ Compact design
- ▶ NG and LPG versions available
- ▶ Horizontal or vertical flue options
- ▶ Frost protection

Ease of installation and maintenance

- ▶ Error codes functionality with optional controller
- ▶ Wall mounted and floor standing options
- ▶ Easy access for maintenance
- ▶ Compact design
- ▶ Internal and external installation
- ▶ Is available in 37°C to 85°C, 37°C to 50°C locked options
- ▶ Commercial grade heat exchanger

Cascading

Linking up to 6 water heaters together in parallel allows a maximum water flow of up to 192 litres per minute with a 25°C rise.

Bosch's intelligent cascading software will automatically rotate the lead appliance after each 8 hours of operation, distributing the workload equally across the water heaters in the cascade, increasing the longevity of the appliances.

Secondary circulation

The Bosch 32C has a durable heat exchanger that allows it to withstand the frequent low-fire rates of a secondary circulation system.

To reduce water wastage, a secondary circulation system will circulate hot water through the pipe work of the property to ensure hot water is immediately available when a tap is opened.

The pump and control system will need to be purchased separately, however no additional accessory is required. A safety valve is mandatory and expansion vessel recommended for recirculating systems.

Use with renewables

A Bosch 32C water heater is designed to work with pre-heated water, for example, from a solar thermal system or heat pump(s).

Fluing

Fluing for internal installations of the Bosch 32C, is a system which is supplied exclusively by Bosch. These high quality flue components are made from polypropylene (PP), making them corrosion resistant, and easy to install.

The 32C flueing includes easy push-fit joints, lightweight components and vertical and horizontal flue terminals.

Technical Data - 32C

| | Bosch 32C |
|---|--|
| Height | 615mm |
| Width | 464mm |
| Depth | 240mm |
| Weight | 33 kg |
| Hot/Cold Water Conn | 3/4" |
| Condensate Conn | 1/2" |
| Gas Connection | 3/4" |
| Maximum Output | 57.5kW |
| Minimum Input | 11 Mj/Hr |
| Maximum Input | 217 Mj/Hr |
| Minimum working, Gas Pressure | 1.13 kPa (NG) 2.75 kPa (LPG) |
| Maximum Static | 3.5 kPa (NG & LPG) |
| Minimum Water Pressure | 200kPa |
| Maximum Water Pressure | 900kPa |
| Minimum Operating Flow Rate | 2.5 l/min |
| Installation | Indoor/Outdoor |
| Air supply/Exhaust | Power Flue |
| Ignition | Direct Electronic Ignition |
| Water holding capacity | 1.9 l/min |
| Maximum Hot Water Capacity (25°C Rise) | 32 l/min |
| Capacity Range | 2.5 -42 l/min |
| Maximum Temperature setting – BC3200RA | 85°C |
| Maximum Temperature setting – BC3200RA5 | 50°C |
| Factory Set Temperature | 60°C |
| Power supply | 230-240 VAC 50Hz |
| Power Consumption | 127W |
| Power Consumption – with antifrost | 185W |
| Power cable | 1.5m |
| Noise Rating | 50dB |
| Relief valve setting | 1620 kPa |
| Manufacturing Material | Casing – Zincified steel plate/ Polyester Powder Coating Flue Collar – Stainless Steel |
| Colour | Munsell 9.3YR8.4/10 |



Inside Story – Bosch 32C

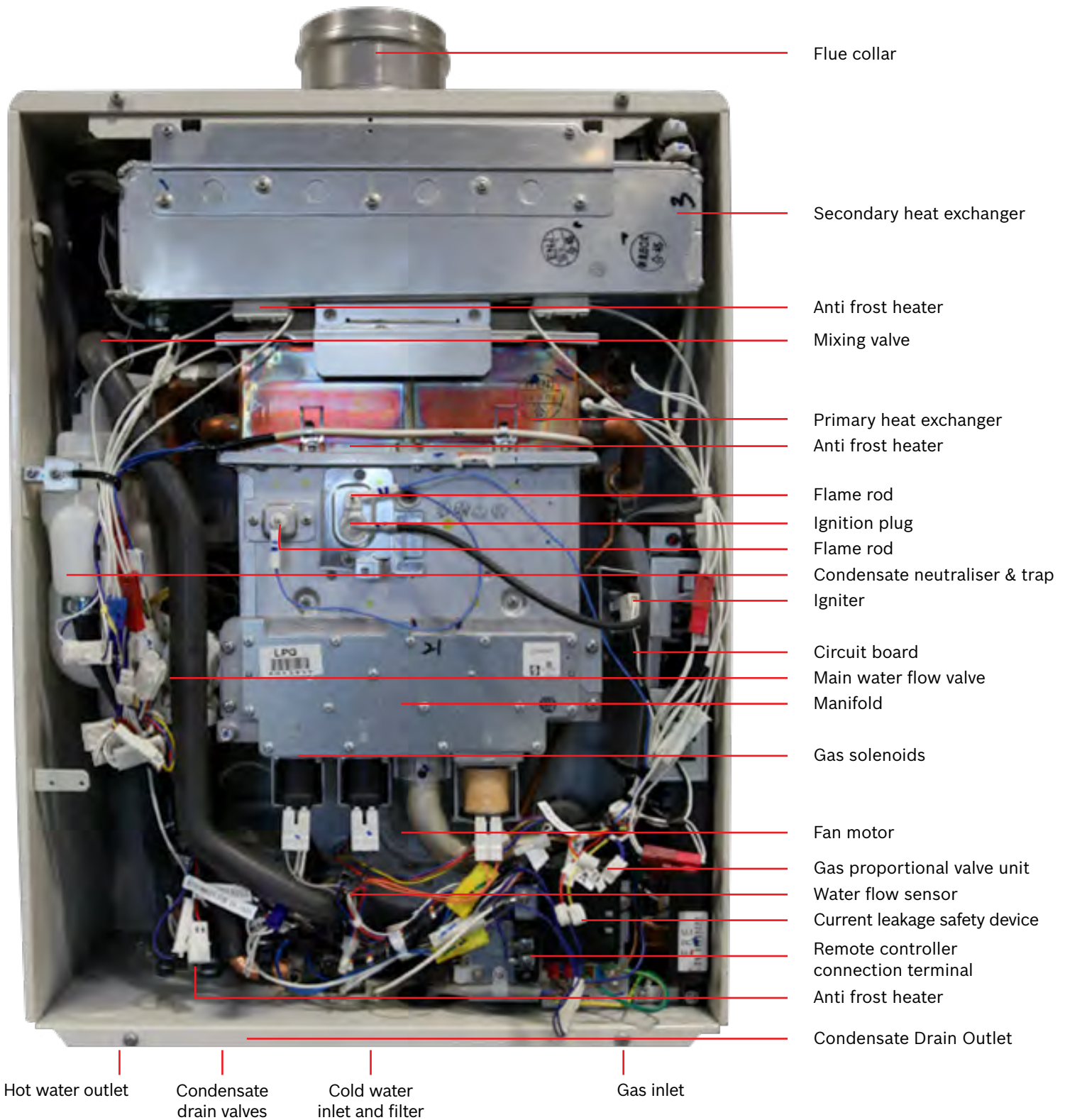

- Flue collar
- Secondary heat exchanger
- Anti frost heater
- Mixing valve
- Primary heat exchanger
- Anti frost heater
- Flame rod
- Ignition plug
- Flame rod
- Condensate neutraliser & trap
- Igniter
- Circuit board
- Main water flow valve
- Manifold
- Gas solenoids
- Fan motor
- Gas proportional valve unit
- Water flow sensor
- Current leakage safety device
- Remote controller connection terminal
- Anti frost heater
- Condensate Drain Outlet

- Hot water outlet
- Condensate drain valves
- Cold water inlet and filter
- Gas inlet

Guidance on installing the Bosch 32C condensing water heater

Siting the appliance

The Bosch 32C can be installed in both indoor and outdoor applications, with the correct flue accessories. Outdoor installations require a vent cap to be installed with the appliances (see page 14), and indoor installations require Bosch PP fluing (see page 14).

Avoid areas where corrosive or flammable gases may be present.

Flue exhaust should be considered when siting the appliance as clearance regulations for both indoor and outdoor installations exist (refer AS/NZS 5601)..

Wall and ceiling clearances

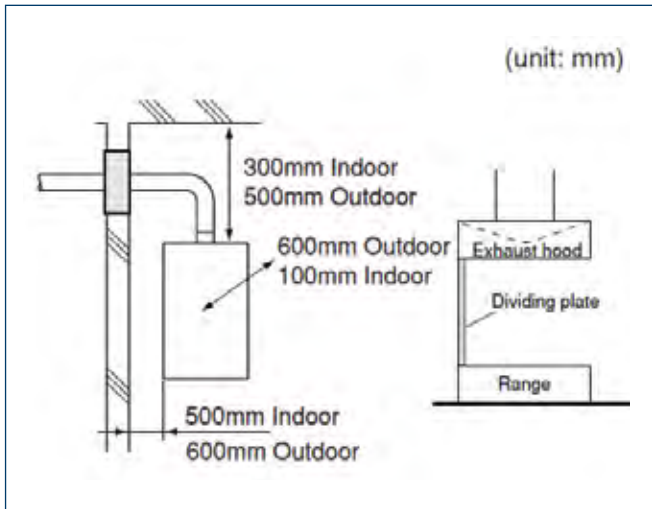

Clearances for ensuring repair/inspection space

The minimum clearances (shown below) should be followed to ensure that sufficient room is available for servicing the appliance.

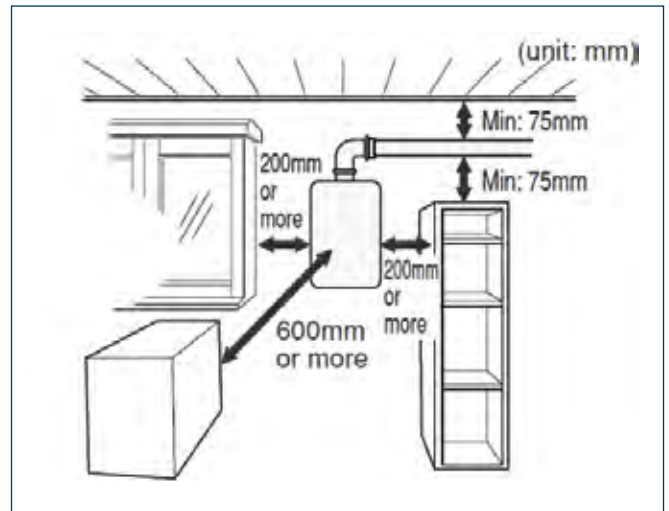

Air inlet

Internal installations of the Bosch 32C require adequate ventilation as per AS/NZS5601. Ensure that the air inlet is adequately sized and is in accordance with AS/NZS5601. The air inlet needs to be open to the outside air from the room or area in which the water heater is used.

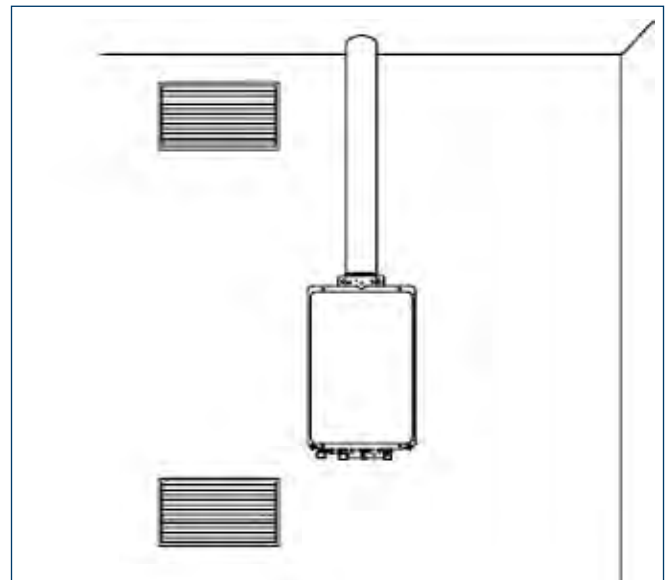

Openings supplying indoor air.

Casing Dimensions

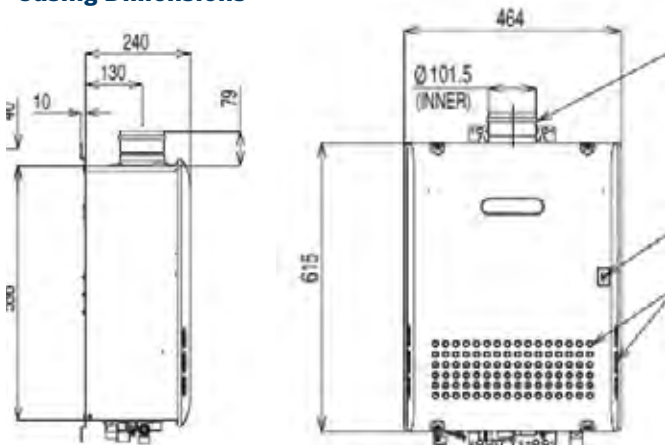

Connection Measurements

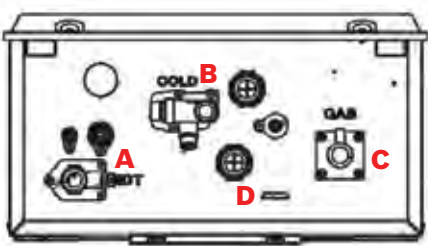

| Pipework Connections | | |
|----------------------|-------------------|------|
| A | Hot water outlet | 3/4" |
| B | Cold water inlet | 3/4" |
| C | Gas connection | 3/4" |
| D | Condensate outlet | 1/2" |

Connection dimensions

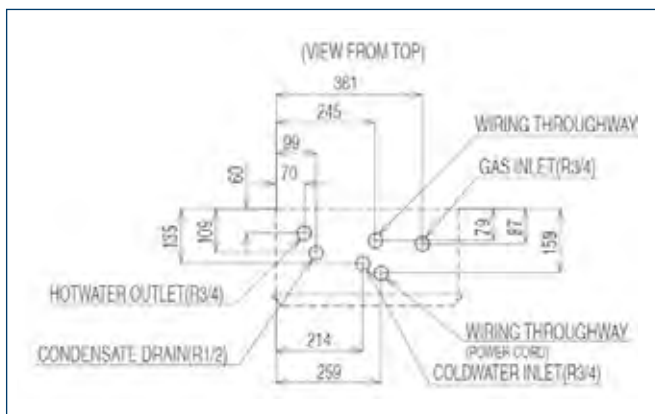

Condensate pipework

This system is supplied with a pre-installed condensate neutralisation system. This neutraliser will remove any acidity that is present in the condensate. This means that no further steps are required to treat the condensate, unless local laws specify otherwise.

In colder areas, considerations should be taken in order to stop the drainline from freezing. If the temperature is likely to drop below 0°C, take measures to prevent the

condensate drain from freezing by installing insulation, heat tape or electric heaters.

Important points to consider when siting a condensate drainage pipe

- ▶ Ensure the plastic piping is no smaller than 3/4" in diameter
- ▶ Use plastic pipe. Do not use steel, black iron or other corrodible material
- ▶ Keep the length of the drainline as short as possible
- ▶ Horizontal runs must be sloped 1/50 downwards towards the drain
- ▶ The drain end should not be submerged in water or blocked in any way

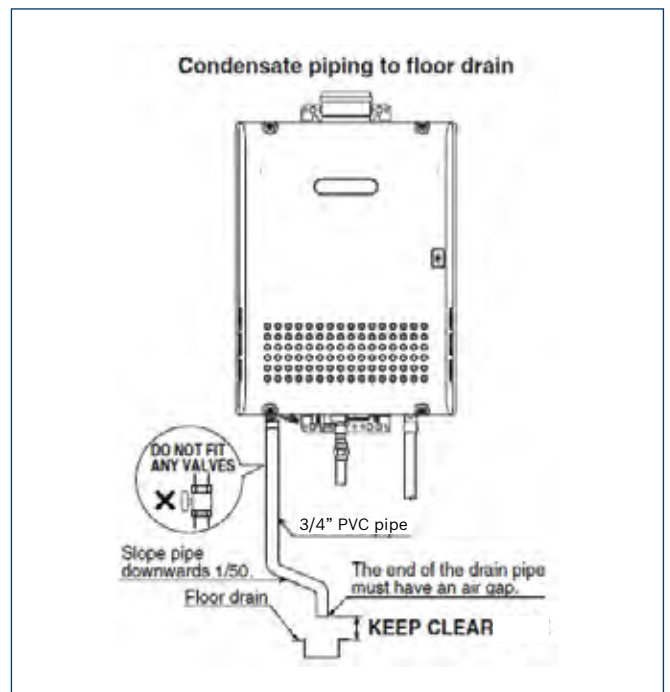

Outdoor clearances to doors & windows

Outdoor installations should have the minimum clearances shown below to ensure that flue exhaust cannot enter into surrounding buildings.

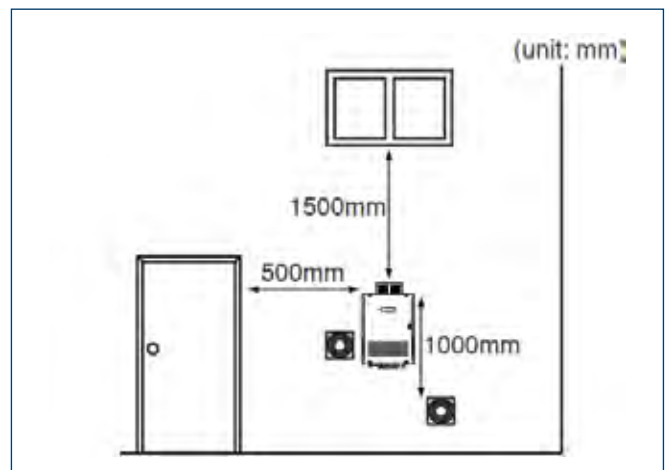

Outdoor Vent Termination

When installing the Bosch 32C outdoors, a Vent Cap is required (code: BCVC-100C).

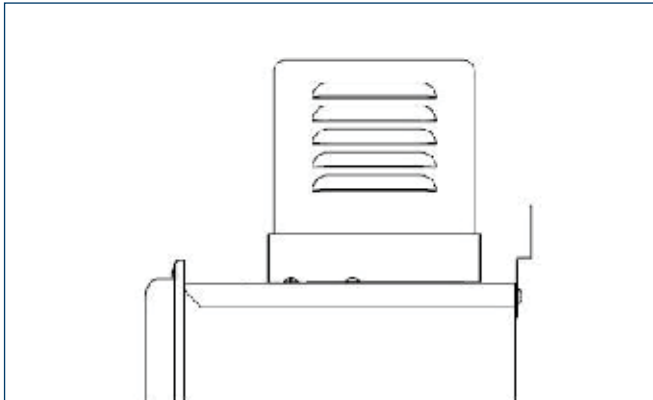

Horizontal Vent Termination

The following considerations must be made when venting horizontally

- ▶ Terminate at least 350mm above the ground
- ▶ Terminate at least 2.3m above public walkways, 2m from the combustion air intake of any appliance, and 1m from any other building opening, gas utility meter or service regulator

Terminate at least (as per AS/NZS5601):

- ▶ 1m above any forced air inlet
- ▶ 1.5m below any door, window or non-mechanical air inlet
- ▶ 0.5m horizontally from any door, window or non-mechanical air inlet
- ▶ 0.3m above any door, window or non-mechanical air inlet
- ▶ Slope the horizontal vent 50mm upwards for every 1m
- ▶ Use a condensation drain if necessary

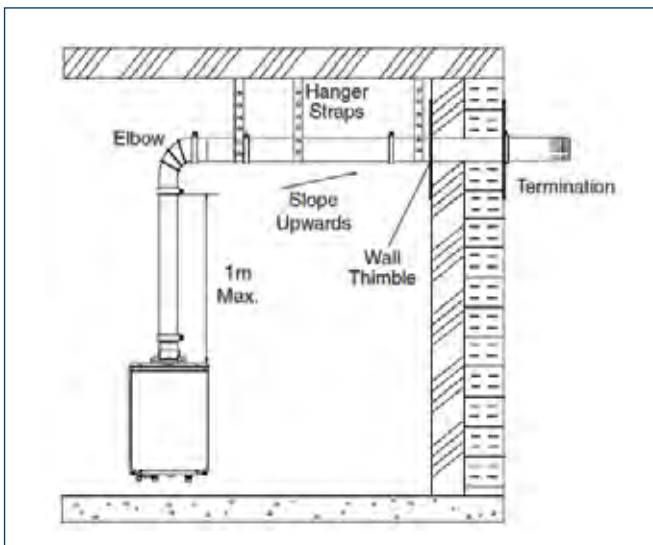

Vertical Vent Termination

The following considerations must be made when venting vertically

- ▶ Terminate at least 1.8m from the combustion air intake of any appliance, and 1m from any other building opening, gas utility meter, service regulator etc
- ▶ Terminate the vent system at least 600mm above but not more than 2m above the roof line
- ▶ Provide vertical support every 3.6m of flue
- ▶ Slope the horizontal vent 50mm upwards for every 1m

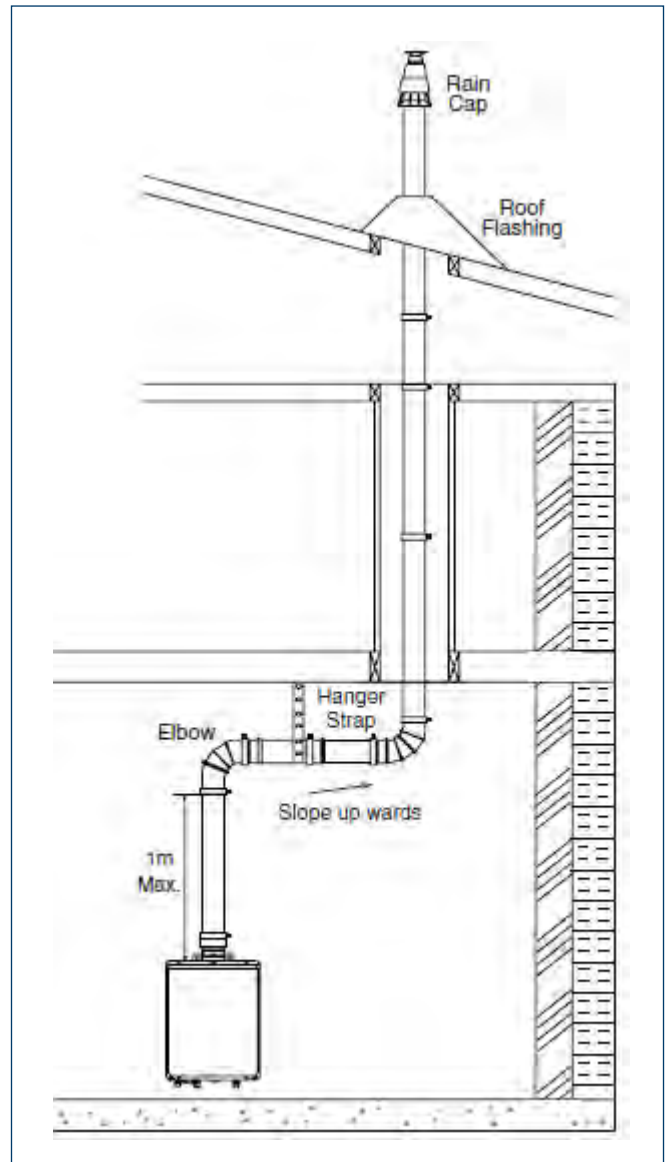

Horizontal and vertical flue terminal positioning

Flue terminal positions for water heaters in accordance with AS/NZS5601.

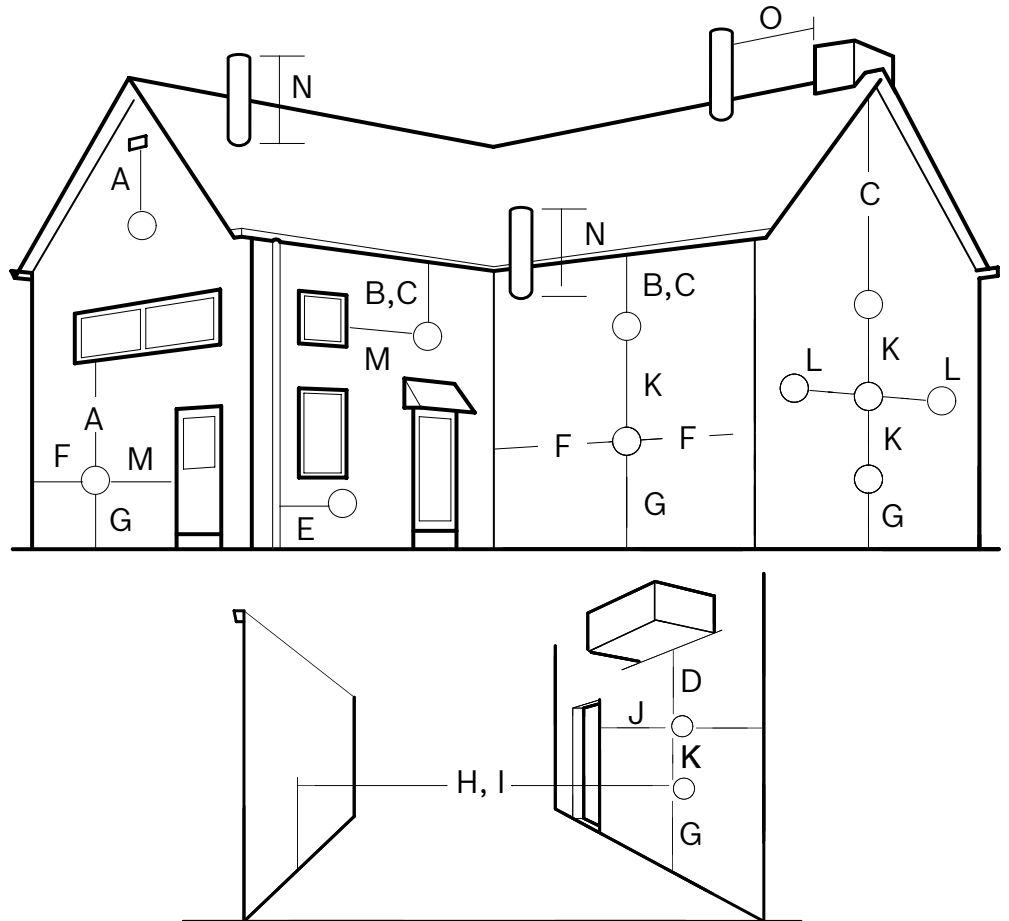

- ▶ The water heater must be installed so that the terminal is exposed to the external air.
- ▶ Plumbing may occur at the terminal. Consideration should be given when choosing a terminal location.
- ▶ It is important that the position of the terminal allows the free passage of air at all times
- ▶ Minimum acceptable spacing from the openings are specified above, in accordance with AS/NZS5601.

Key to illustration

| Balanced flue terminal position | | |
|---------------------------------|---|-----------------|
| Terminal Position | | Minimum Spacing |
| A | Directly below, above or alongside an opening window, air vent or other ventilation opening | 1,500mm |
| B | Below guttering, drain pipes or soil pipes | 75mm |
| C | Below eaves | 300mm |
| D | Below balconies or a car port roof* | 300mm |
| E | From vertical drain pipes or soil pipes | 75mm |
| F | From internal or external corners | 300mm |
| G | Above adjacent ground, roof or balcony level | 300mm |
| H | From a surface facing the terminal | 1,500mm |
| I | From a terminal facing the terminal | 1,200mm |
| K | Vertically from a terminal on the same wall | 1,500mm |
| L | Horizontally from a terminal on the wall | 300mm |
| M | Adjacent to opening | 1,500mm |
| N | Above intersection with roof | 500mm |
| O | For a vertical structure on the roof | 500mm |









Bosch 32C water heater

Flueing configurations

The Bosch 32C water heater uses the 100mm polypropylene flue system supplied by Bosch.

The maximum flue length is 13m. For every 90 degree elbow subtract 2m from the maximum length. For every 45 degree elbow subtract 1m from the maximum length.

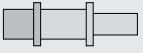
Available flue components

| Components | Part No. | Description |
|---|-----------|--|
|  | BCVC-100C | Stainless Steel Vent Cap |
|  | MG85176 | PP extension pipe 100 x 500m |
|  | MG85177 | PP extension pipe 100 x 1000mm |
|  | MG 85181 | PP flue elbow, 90°, 100m diameter |
|  | MG85182 | PP flue elbow, 45°, 100mm diameter |
|  | MG84631 | Wall bracket suitable for 32C flueing |
|  | MG87930 | Horizontal wall terminal, PP & aluminum 100mm diameter |
|  | MG84862 | Vertical roof terminal, PP, 100/150mm dia, incl air cover MG75439 |
|  | MG27356 | Sealing Ring, please note: 1 unit required for every internal installation |

The following considerations should be made when planning the installation

- ▶ Use only Bosch flue materials
- ▶ Vertical sections of flue must be as short as possible
- ▶ Maintain the same flue pipe diameter throughout the entire flue
- ▶ Ensure that connections are gas tight and will not leak. Use heat resistant silicon sealant wherever necessary
- ▶ Use a maximum of 1m straight pipe before the first elbow

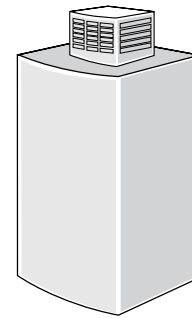



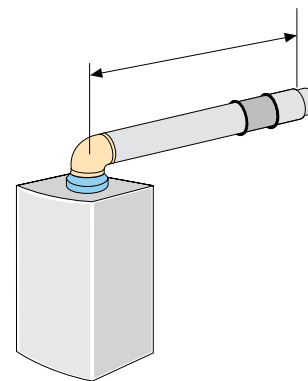

Outdoor installation

| Components |  |
|---|---|
| Part Numbers | BCVC-100C |
| Maximum length (mm) & no. of components required | |
| N/A | 1 |





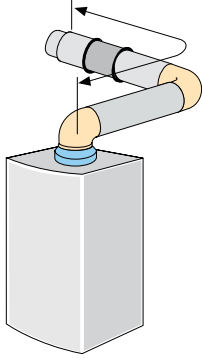

Standard internal horizontal flue assembly

| Components |  |  |  |  |
|---|---|---|---|---|
| Part Numbers | MG27356 | MG85181 | MG85176 MG85177 | MG87930 |
| Maximum length (mm) & no. of components required | | | | |
| 11,000 | 1 | 1 | 1 or more | 1 |





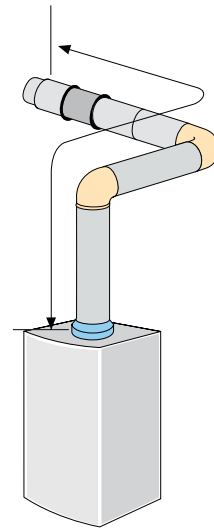

Standard horizontal flue assembly with 90° bend

| Components |  |  |  |  |
|---|---|---|---|---|
| Part Numbers | MG27356 | MG85181 | MG85176 MG85177 | MG87930 |
| Maximum length (mm) & no. of components required | | | | |
| 9,000 | 2 | 2 | 2 or more | 1 |





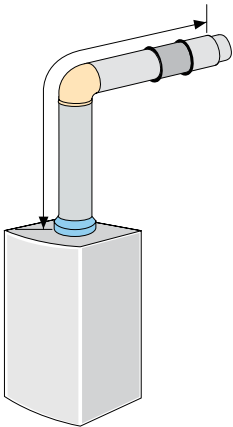

Extension horizontal flue with two 90° bends

| Components |  |  |  |  |
|---|---|---|---|---|
| Part Numbers | MG27356 | MG85181 | MG85176 MG85177 | MG87930 |
| Maximum length (mm) & no. of components required | | | | |
| 9,000 | 1 | 2 | 3 or more | 1 |



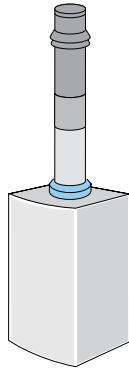

Extension horizontal with one 90° bend

| Components |  |  |  |  |
|---|---|---|---|---|
| Part Numbers | MG27356 | MG85181 | MG85176 MG85177 | MG87930 |
| Maximum length (mm) & no. of components required | | | | |
| 11,000 | 1 | 2 | 2 or more | 1 |





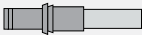

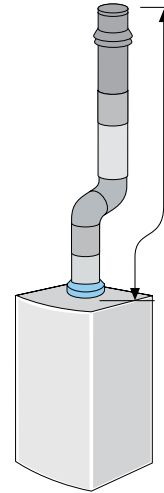
Standard vertical flue - Minimum length

| Components |  |  |  |
|---|---|---|---|
| Part Numbers | MG27356 | MG85176 | MG84862 |
| Maximum length (mm) & no. of components required | | | |
| 500 | 1 | 1 | 1 |



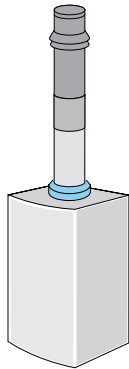

Vertical flue - two 45° bends

| Components |  |  |  |  |
|---|---|---|---|---|
| Part Numbers | MG27356 | MG85176 MG85177 | MG85182 | MG84862 |
| Maximum length (mm) & no. of components required | | | | |
| 11000 | 1 | 2 or more | 2 | 1 |





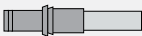

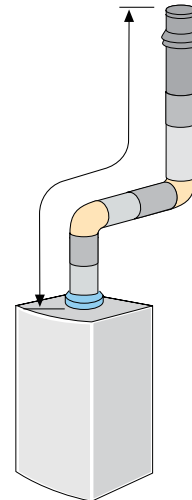
Standard vertical flue - Maximum length

| Components |  |  |  |
|---|---|---|---|
| Part Numbers | MG27356 | MG85176 | MG84862 |
| Maximum length (mm) & no. of components required | | | |
| 13000 | 1 | 1 or more | 1 |



Vertical flue - two 90° bends

| Components |  |  |  |  |
|---|---|---|---|---|
| Part Numbers | MG27356 | MG85176 MG85177 | MG85181 | MG84862 |
| Maximum length (mm) & no. of components required | | | | |
| 9000 | 1 | 2 or more | 2 | 1 |

Note: The maximum flue length must be reduced by the following amounts for each bend used.

| Bosch 32C 100mm flues | |
|------------------------------|----|
| 45° Bend | 1m |
| 90° Bend | 2m |



The **Bosch** 32 and 32Q water heaters

| | Bosch 32 & 32Q |
|----------------------------|----------------------------|
| Part No NG | KM3211WHNG KM3211WHQNG* |
| Part No LPG | KM3211WHLP KM3211WHQLP* |
| Output (kW) | Max 55 kW |
| Input (Mj/h) Max | 250 |
| Input (Mj/h) Min | 20 (NG) 18 (LPG) |
| Flow rate at 50°C | 16L |
| Flow rate at 25°C | 32L |
| Install Application | Internal or External |
| Available Gas Type | Natural & LP Gas |
| Star Rating | 4.8 |
| Efficiency | 77.4% |

*Single appliance application only

| Features | Benefits |
|---|---|
| Continuous flow hot water heater | On demand and sustained delivery |
| Natural gas and LPG models | Fuel flexibility |
| Up to 3 temperatures controllers | Remote temperature control and service and maintenance assistance |
| Water temperature adjustment connector | Ability to adjust to multiple temperature settings without controller |
| Direct integration with solar heating | Adaptable to ecologically sustainable design requirements |
| Accessory to control manifold of up to 6 appliances | Maximises output up to 192 l/min at a 25 deg. temperature rise |
| Internal / External installation | Installation flexibility |

The features of the 32 commercial water heater

Designed for commercial reliability

The Bosch 32 has been designed for the Australian and New Zealand commercial environment. With a 25% thicker commercial grade heat exchanger to aid prevention of corrosion and deterioration, the Bosch 32 is a hardwearing appliance that will last longer in high demand hot water applications.

Applications

Suitable for any high demand environment the Bosch 32 water heater is ideal for large domestic and commercial applications.

At 55kW heating output, the Bosch 32 water heater offers the following performance:

- ▶ Up to 16 litres per minute with 50°C rise
- ▶ Up to 32 litres per minute with 25°C rise

The Bosch 32 water heater can be used with NG or LPG and can be installed as a single appliance or multiples of up to 6 units with appropriate accessories.

Extended flue lengths of up to 13m are also possible, helping to provide even greater design flexibility.

Large Domestic

The Bosch 32 water heater is ideal for large domestic applications where:

- ▶ There is increased demand for DHW – e.g. multiple fixtures such as sinks and showers
- ▶ Pre-heated water supply is to be used – e.g. by solar thermal

Light commercial

Ideal for light commercial applications with:

- ▶ High demands for DHW – e.g. multiple fixtures such as sinks and showers
- ▶ Where demands for DHW are consistent throughout the day

Commercial

Suitable for large commercial applications where there is:

- ▶ Consistent high demands for DHW – e.g. Processing plants, hospitals
- ▶ Very high cyclic demands for DHW – e.g. hotels, schools

The Bosch 32C's ability to use water pre-heated by renewable heat sources supports planning and investment requirements.

Such applications can take full advantage of the cascade controls that are part of the Bosch 32 offering. These controls provide the ability to deliver up to 192 litres of hot water a minute, on demand.

Certain commercial applications may also take advantage of the ability to provide a hot water temperature of up to 83°C for sterilisation processes and secondary circulation.

Key benefits to the user

High volumes

- ▶ Use of multiple fixtures such as sinks and showers

Cost savings

- ▶ Low maintenance and replacement costs
- ▶ Compact size and modular design allows low cost retrofit installations

Low environmental impact

- ▶ Solar compatible system suitable for use with pre-heated water from renewables
- ▶ Compatible with hot water secondary circulation to reduce water wastage

Key benefits for installers

- ▶ Flexible design options
- ▶ Compact, low-space design
- ▶ NG and LPG versions
- ▶ Horizontal or vertical flue options
- ▶ Frost protection

Ease of installation and maintenance

- ▶ Error codes functionality with optional controller
- ▶ Wall mounted and floor standing options
- ▶ Easy access to components
- ▶ Compact design
- ▶ Internal and external installation
- ▶ Available in 37°C – 83°C
- ▶ Commercial grade heat exchanger

Cascading

With optional system controllers linking up to 6 water heaters together in parallel allows a maximum water flow of up to 192 litres per minute with a 25°C rise.

Bosch’s intelligent cascading software will automatically rotate the lead appliance after each 8 hours of operation, distributing the workload equally across the water heaters in the cascade, increasing the longevity of the appliances.



The features of the 32Q commercial water heater



The Bosch 32Q has been designed for flow and return applications. With the same 25% thicker commercial grade heat exchanger as the Bosch 32, the Bosch 32Q is a hardwearing appliance that will last longer in high demand hot water applications. The Bosch 32Q internal pump allows for programmed water recirculation in peak usage times. This results in fast delivery of hot water to the fixtures, with minimal water wastage.

Applications

Suitable for any high demand environment the Bosch 32Q water heater is ideal for large domestic and commercial applications with long runs to hot water outlets.

The Bosch 32Q can only be used as a single appliance in flow and return applications. The Bosch 32Q cannot be used in series or cascade applications.

At 55kW heating output, the Bosch 32Q water heater offers the following performance:

- ▶ Up to 16 litres per minute with 50°C rise
- ▶ Up to 32 litres per minute with 25°C rise

The Bosch 32Q water heater can be used with NG or LPG.

When installing the 32Q, ensure the following is adhered to- the maximum flow and return length should be no greater than 60m in total with a maximum of 20 bends

- ▶ The flow should be 3/4" with a return of 1/2"
- ▶ Insulation on the pipework should meet R3 standard or above
- ▶ No branch lines or fittings off the return line
- ▶ Tempering valves, where required should only be fitted to branch lines

Extended flue lengths of up to 13m are also possible, helping to provide even greater design flexibility.

The Bosch 32Q water heater is ideal for larger applications where there are long hot water lines such as:

Large Domestic

- ▶ use of multiple fixtures such as sinks and showers
- ▶ Pre-heated water supply is to be used – e.g. by solar thermal

Typical examples include larger homes.

Key benefits to the end user

High volumes of hot water

- ▶ Multiple showers, sinks and baths at the same time

Cost savings

- ▶ Low maintenance and replacement costs
- ▶ Integrated timer function can restrict recirculation to the times when it is required

Key benefits for installers

- ▶ Compact, low-space design
- ▶ NG and LPG versions
- ▶ Horizontal or vertical flue options
- ▶ Frost protection

Ease of installation and maintenance

- ▶ Error code functionality with supplied controller
- ▶ Easy access to components
- ▶ Compact design
- ▶ Internal and external installation
- ▶ Is available in 37°C – 80°C
- ▶ Commercial grade heat exchanger

Technical Data - 32 & 32Q

| | Bosch 32 | Bosch 32Q |
|--|--|-----------------------|
| Height | 615mm | |
| Width | 464mm | |
| Depth | 240mm | |
| Weight | 29 kg | 32 kg |
| Hot/Cold Water Conn | 3/4" Male | |
| Hot Water Return | - | 1/2" Male |
| Gas Connection | 3/4" Male | |
| Maximum Output | 55kW | |
| Minimum Input | 20Mj/Hr (NG) - 18Mj/Hr (LPG) | |
| Maximum Input | 250 Mj/Hr | |
| Minimum Gas Pressure | 1.13 kPa (NG) 2.75 kPa (LPG) | |
| Maximum Gas Pressure | 3.5 kPa (NG & LPG) | |
| Minimum Water Pressure | 200kPa | |
| Maximum Water Pressure | 900kPa | |
| Minimum Operating Flow Rate | 3.5 l/min | |
| Installation | Indoor/Outdoor | |
| Air supply/Exhaust | Fan Assisted | |
| Ignition | Electronic Ignition | |
| Water holding capacity | 1.1 l/min | |
| Maximum Hot Water Capacity (25°C Rise) | 32 l/min | |
| Capacity Range | 3.0 – 32.0 l/min | |
| Maximum Temperature setting | 83°C | 80°C |
| Factory Set Temperature | 60°C | |
| Power supply | 230-240 VAC 50Hz | |
| Power Consumption | 100W(NG) 115W(LPG) | 135W(NG) 150W(LPG) |
| Power Consumption – with antifrost | 115W | 140W |
| Power cable | 1.5m | |
| Noise Rating | 50dB | |
| Relief valve setting | 1620 kPa | |
| Manufacturing Material | Casing – Zincified steel plate/ Polyester Coating. Flue Collar – Stainless Steel | |
| Colour | Munsell 9.3YR8.4/10 | |



Inside Story – Bosch 32

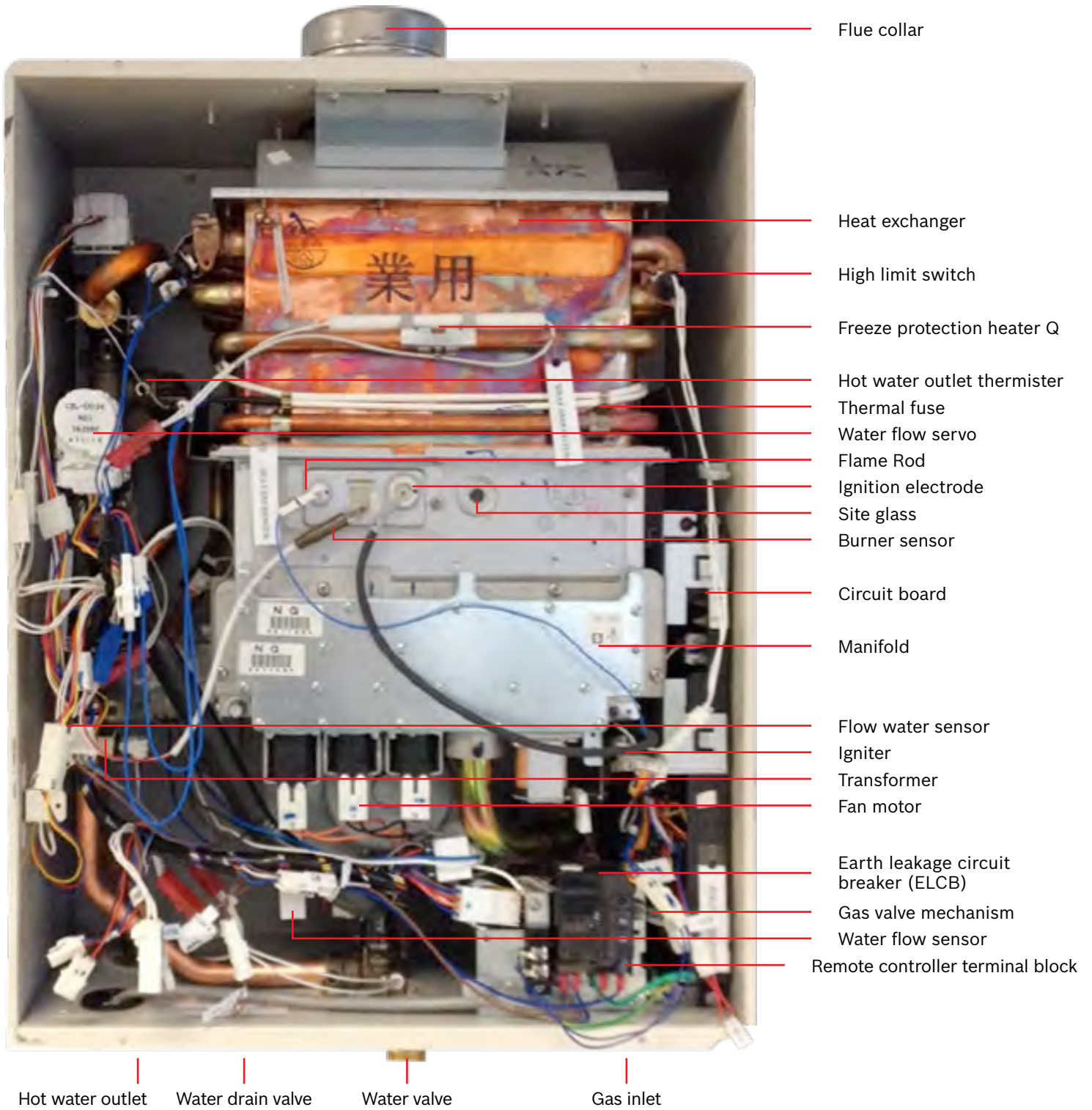

Inside Story – Bosch 32Q

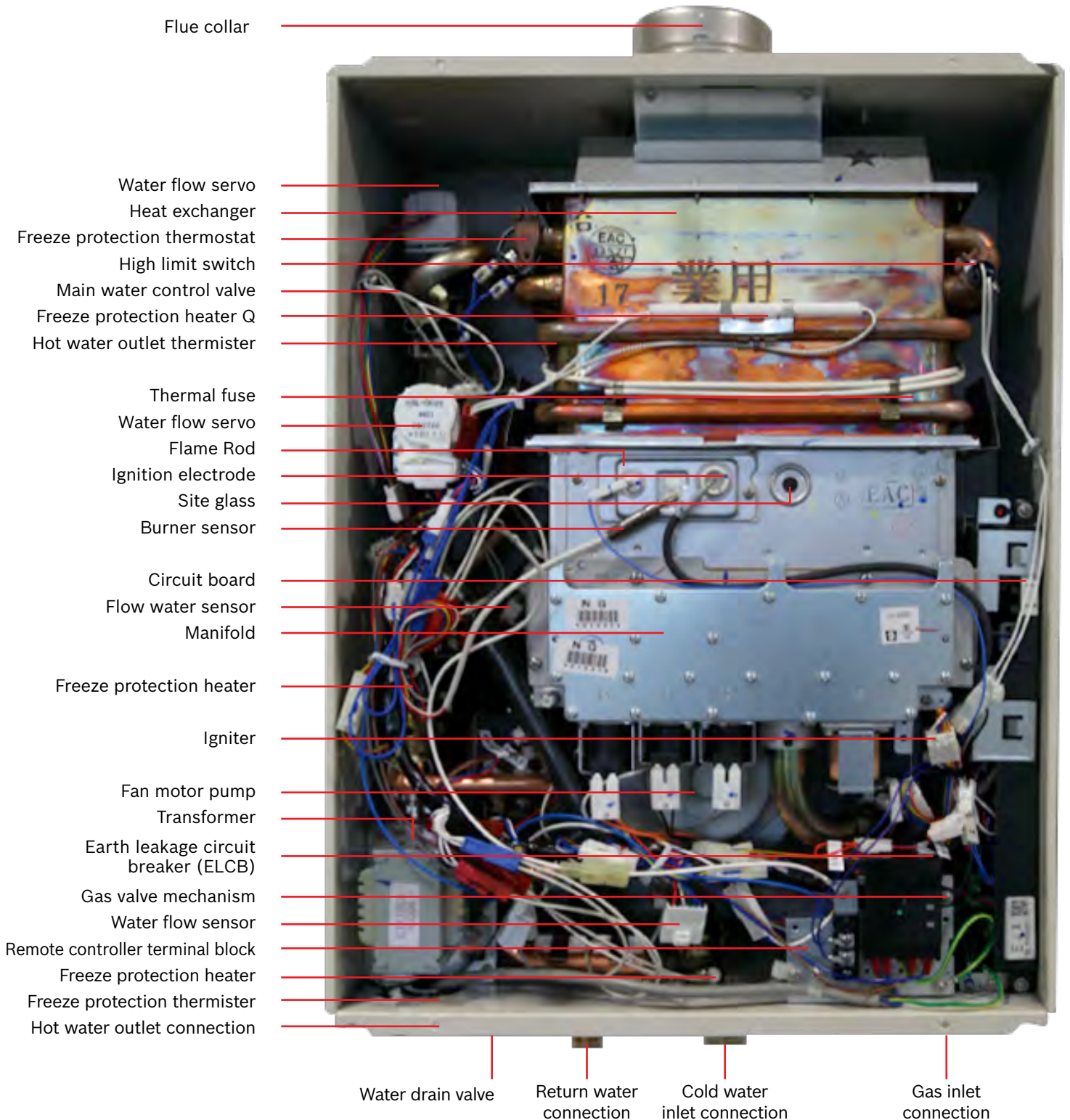

Guidance on installing the Bosch 32 and 32Q water heaters

Choosing the location

The Bosch 32 and 32Q can be installed in both indoor and outdoor applications, with the correct flue accessories. Outdoor installations require vent caps to be installed with the appliances (see page 28), and indoor installations require Bosch stainless steel fluing (see page 28).

Avoid areas where corrosive or flammable gases may be present.

Flue exhaust should be considered when siting the appliance as clearance regulations for both indoor and outdoor installations exist.

Wall and ceiling clearances

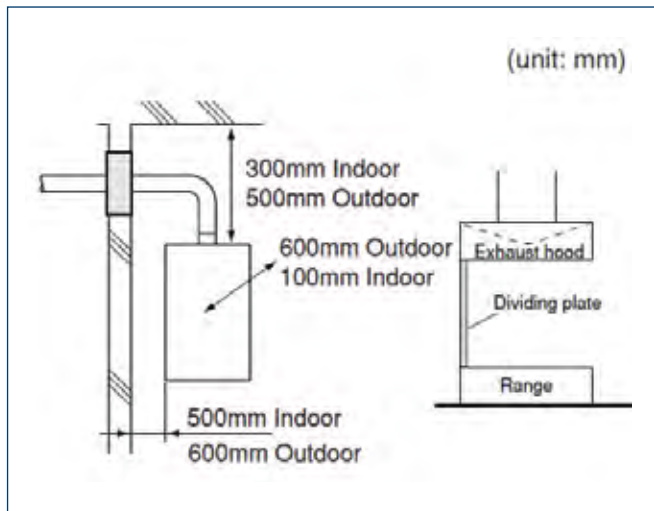

Clearances for ensuring repair/inspection space

The minimum clearances (shown below) should be followed to ensure that sufficient room is available for servicing the appliance.

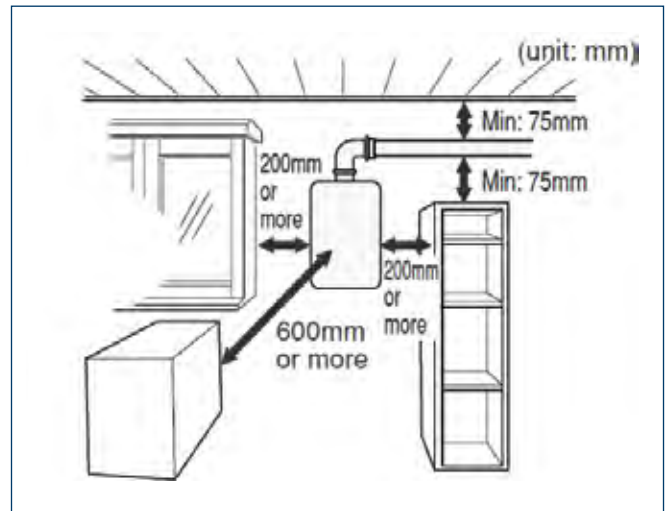

Air inlet

Internal installations of the Bosch 32 require adequate ventilation as per AS/NZS5601.. Ensure that the air inlet is adequately sized and is in accordance with AS/NZS5601. The air inlet needs to be open to the outside air from the room or area in which the water heater is used.

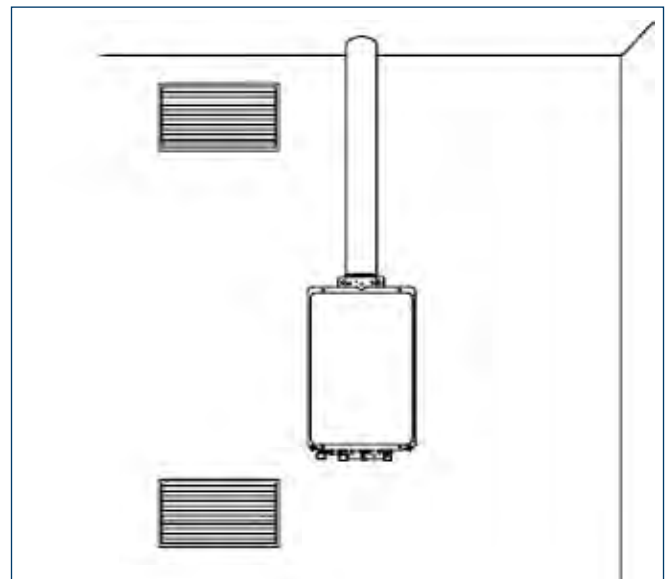

Openings supplying indoor air.

Connection Dimensions

Casing Dimensions

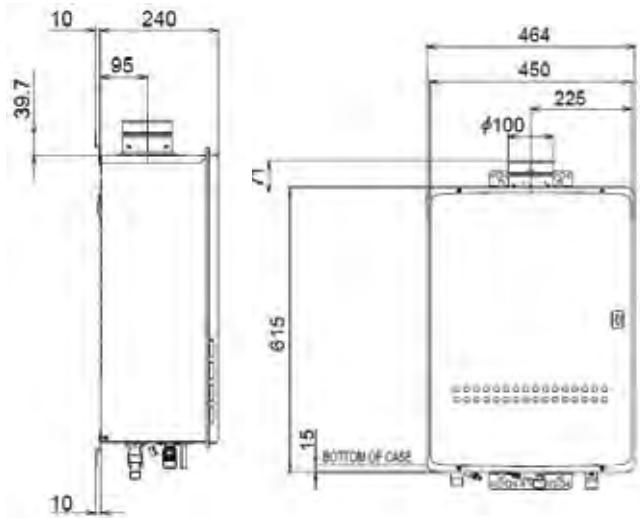

Connection Measurements – Bosch 32

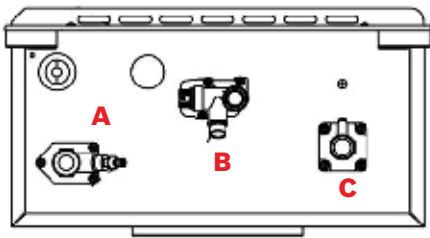

| Pipework Connections | | |
|----------------------|------------------|-----------|
| A | Hot water outlet | 3/4" Male |
| B | Cold water inlet | 3/4" Male |
| C | Gas connection | 3/4" Male |

Connection Measurements – Bosch 32Q

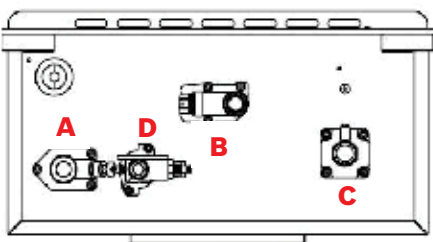

| Pipework Connections | | |
|----------------------|------------------------|-----------|
| A | Hot water outlet | 3/4" Male |
| B | Cold water inlet | 3/4" Male |
| C | Gas connection | 3/4" Male |
| D | Hot water return inlet | 1/2" Male |

Connection dimensions

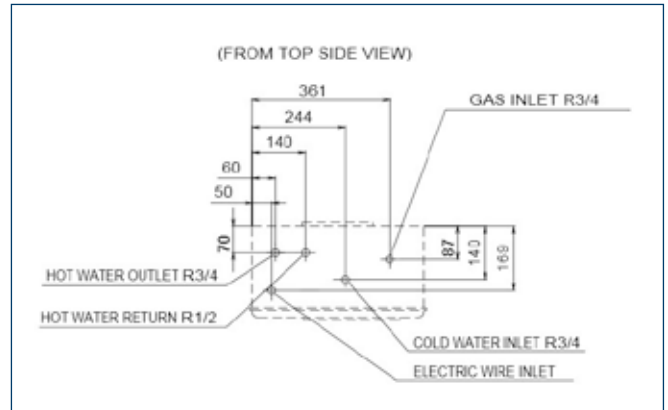

Outdoor clearances to doors & windows

Outdoor installations should have the minimum clearances shown below to ensure that flue exhaust cannot enter into surrounding buildings.

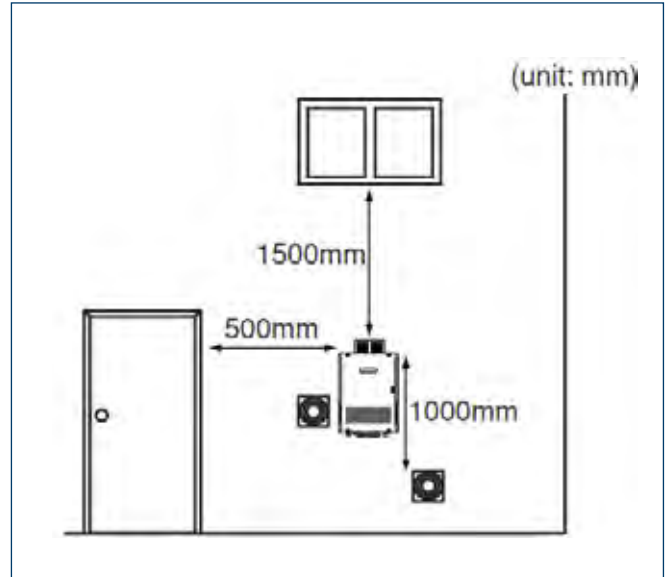

Outdoor Vent Termination

When installing the Bosch 32 outdoors a Vent Cap is required (code: KMVC-100)

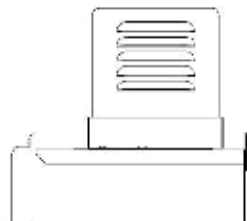

Guidance on installing the Bosch 32 water heater

Horizontal vent termination

The following considerations must be made when venting horizontally

- ▶ Terminate at least 350mm above the ground
- ▶ Terminate at least 2.3m above public walkways, 2m from the combustion air intake of any appliance, and 1m from any other building opening, gas utility meter, or service regulator

Terminate at least (as per AS/NZS5601):

- ▶ 1m above any forced air inlet
- ▶ 1.5m below any door, window or non-mechanical air inlet
- ▶ 0.5m horizontally from any door, window or non-mechanical air inlet
- ▶ 0.3m above any door, window or non-mechanical air inlet
- ▶ Slope the horizontal vent 500mm upwards for every 1m
- ▶ Use a condensation drain if necessary

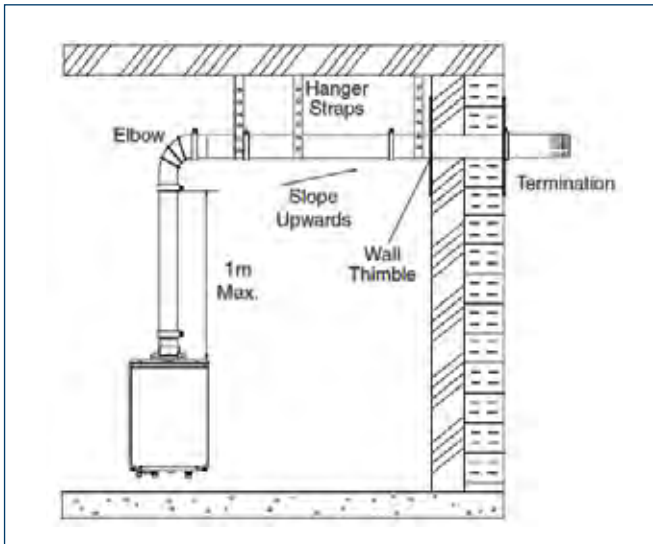

Vertical vent termination

The following considerations must be made when venting vertically

- ▶ Terminate at least 1.8m from the combustion air intake of any appliance, and 1m from any other building opening, gas utility meter, service regulator etc
- ▶ Terminate the vent system at least 600mm above but not more than 2m above the roof line
- ▶ Provide vertical support every 3.6m
- ▶ Slope the horizontal vent 50mm downwards for every 1m

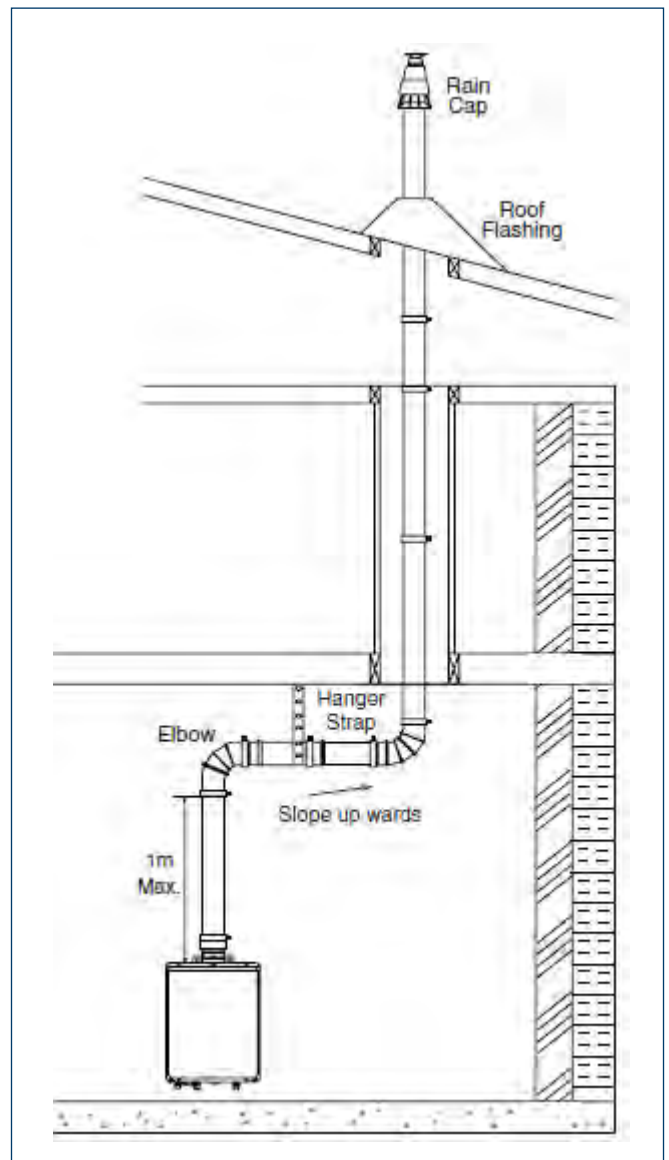

Horizontal and vertical flue terminal positioning

Flue terminal positions for water heaters in accordance with AS/NZS5601.

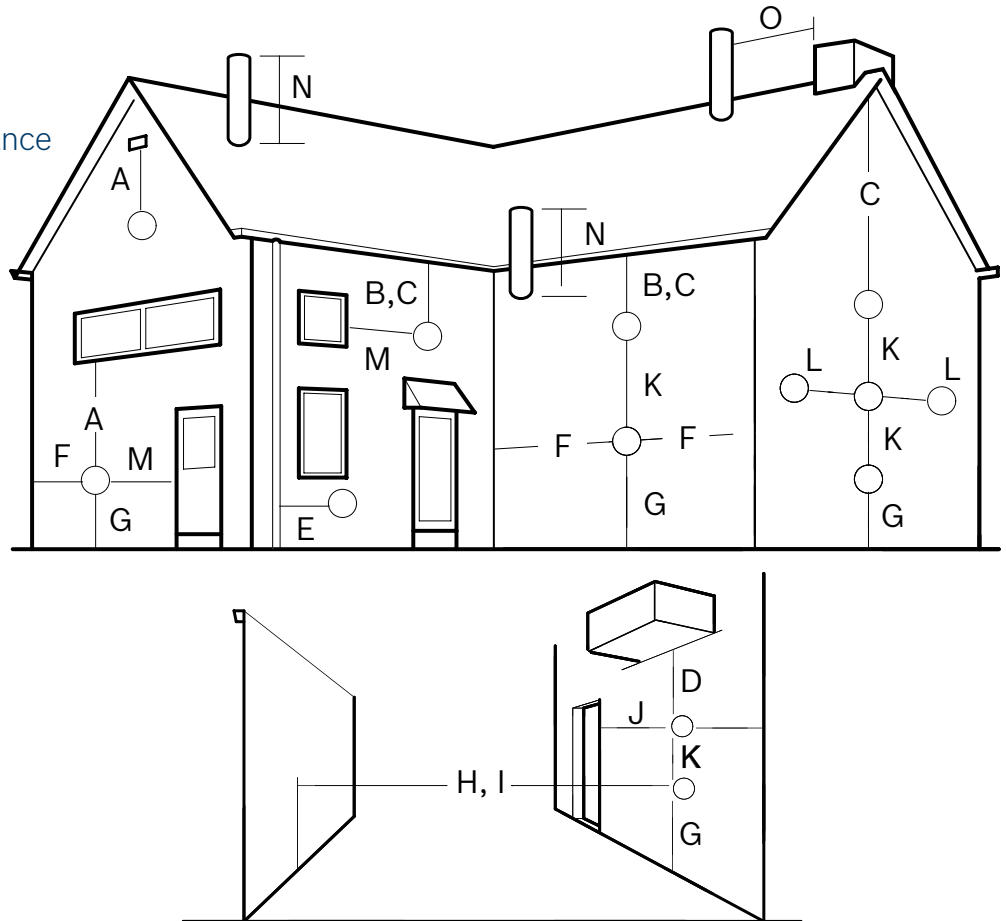

- ▶ The water heater must be installed so that the terminal is exposed to the external air
- ▶ It is important that the position of the terminal allows the free passage of air at all times
- ▶ Minimum acceptable spacing from the openings are specified above, for domestic situations in accordance with AS/NZS5601

Key to illustration

| Balanced flue terminal position | | |
|---------------------------------|---|-----------------|
| Terminal Position | | Minimum Spacing |
| A | Directly below, above or alongside an opening window, air vent or other ventilation opening | 1,500mm |
| B | Below guttering, drain pipes or soil pipes | 75mm |
| C | Below eaves | 300mm |
| D | Below balconies or a car port roof* | 300mm |
| E | From vertical drain pipes or soil pipes | 75mm |
| F | From internal or external corners | 300mm |
| G | Above adjacent ground, roof or balcony level | 300mm |
| H | From a surface facing the terminal | 1,500mm |
| I | From a terminal facing the terminal | 1,200mm |
| K | Vertically from a terminal on the same wall | 1,500mm |
| L | Horizontally from a terminal on the wall | 300mm |
| M | Adjacent to opening | 1,500mm |
| N | Above intersection with roof | 500mm |
| O | For a vertical structure on the roof | 500mm |

Bosch 32 & Bosch 32Q

Flueing configurations

The Bosch 32 and 32Q water heaters are flued by the flue kits available. The vertical and horizontal flue kits contain components required for most applications. The maximum acceptable flue length is 13m. For every 90 degree elbow 2m should be subtracted from this length. All internal gas water heaters must be flued and installed with adequate ventilation in accordance with AS/NZS5601.

Vertical Flue Kit

The vertical flue kit contains the following components

- ▶ 100mm gas cowl
- ▶ 1.5m x 100mm diameter gas flex (3 piece)
- ▶ Flue pipe adaptor (3 pieces)
- ▶ Support struts (2 pieces)
- ▶ 3m x 6mm condensation hose

Horizontal Flue Kit

The horizontal flue kit contains the following components

- ▶ 100mm diameter flexible flue, 5m long
- ▶ Flue sleeve
- ▶ Adjustable wall penetration sleeve (2 pieces)
- ▶ Clamp

The following considerations should be made when planning the installation

- ▶ Vertical sections of flue must be as short as possible
- ▶ Ensure the joints are gas tight and will not leak. Use heat resistant silicon sealant wherever necessary.
- ▶ Use a maximum of 1m straight pipe before the first elbow

Available flue components

| Components | Part No. | Description |
|---|----------|-----------------------------------|
|  | KMVC-100 | Vent Cap |
| | FKV32LTR | Vertical Flue Kit |
| | FKH32LTR | SS flue elbow, 90°, 100m diameter |

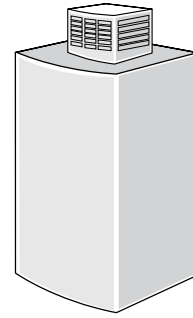

Outdoor installation

| Components |  |
|--|---|
| Part Numbers | KMVC-100 |
| Maximum length (mm) & no. of components required | |
| N/A | 1 |

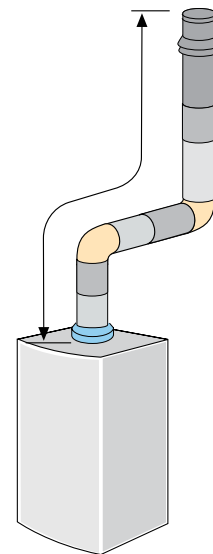

Standard vertical flue kit

| Part No 100mm | FKV32LTR |
|--|----------|
| Maximum length (mm) & no. of components required | |
| 9m | 1 kit |

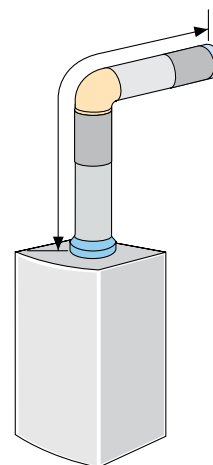

Standard horizontal flue kit

| Part No 100mm | FKH32LTR |
|--|----------|
| Maximum length (mm) & no. of components required | |
| 11m | 1 kit |

System Layouts

Flow and return applications

The Bosch 32 has a durable heat exchanger that allows it to withstand the frequent low-fire rates of a flow and return system.

To reduce water wastage, a flow and return system will circulate hot water through the pipe work of the property to ensure hot water is immediately available when a tap is opened.

A thermostat placed in the pipe work at a distant point to the heater activates a pump when water temperature drops below a set point, thus activating the appliance.

Bosch supplies Wilo dual secondary pump systems and thermostats to be installed in flow and return applications. For the performance of these pumps please refer page 36.

The pump will need to be purchased separately, however no additional accessory is necessary. A safety valve is mandatory and expansion vessel recommended for recirculating systems.

Use with renewables

A Bosch 32 series water heaters are designed to work with pre-heated water from, for example a solar thermal system or heat pump system.

System Layouts

Bosch 32 water heater Domestic Flow and Return Applications Layout

Note: Suitable layout for Bosch 32Q ONLY

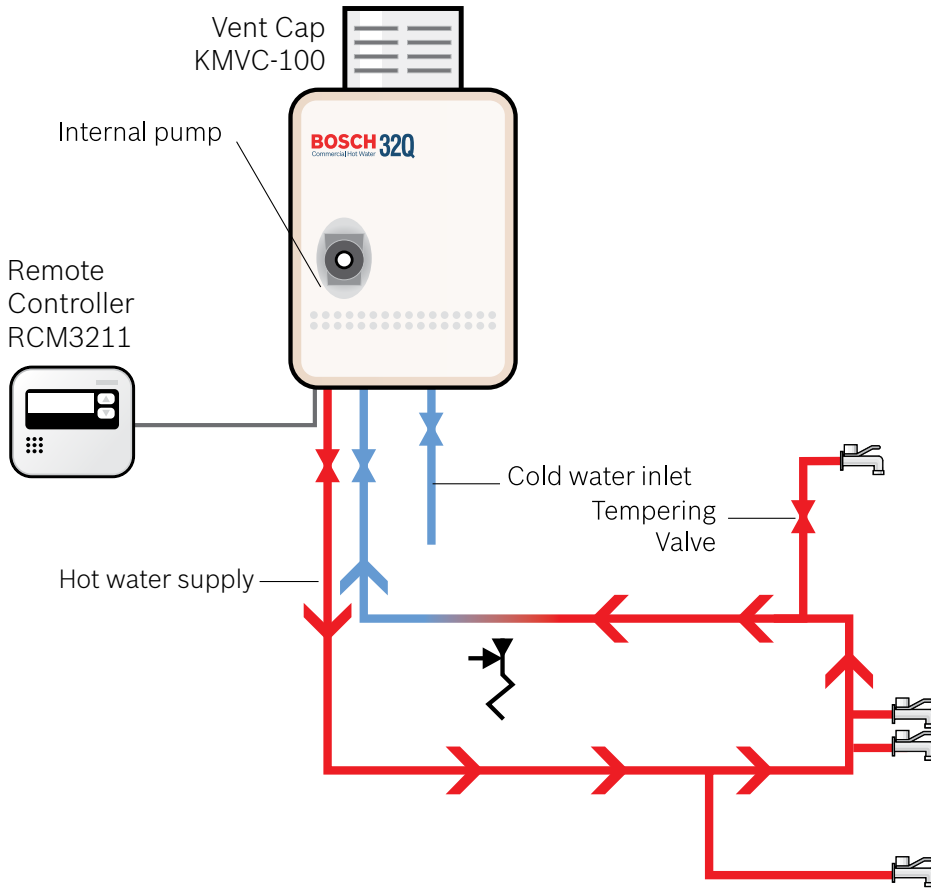

Bosch 32 Water Heater Cascade Application Layouts

Note: Suitable layout for Bosch 32 & 32C ONLY

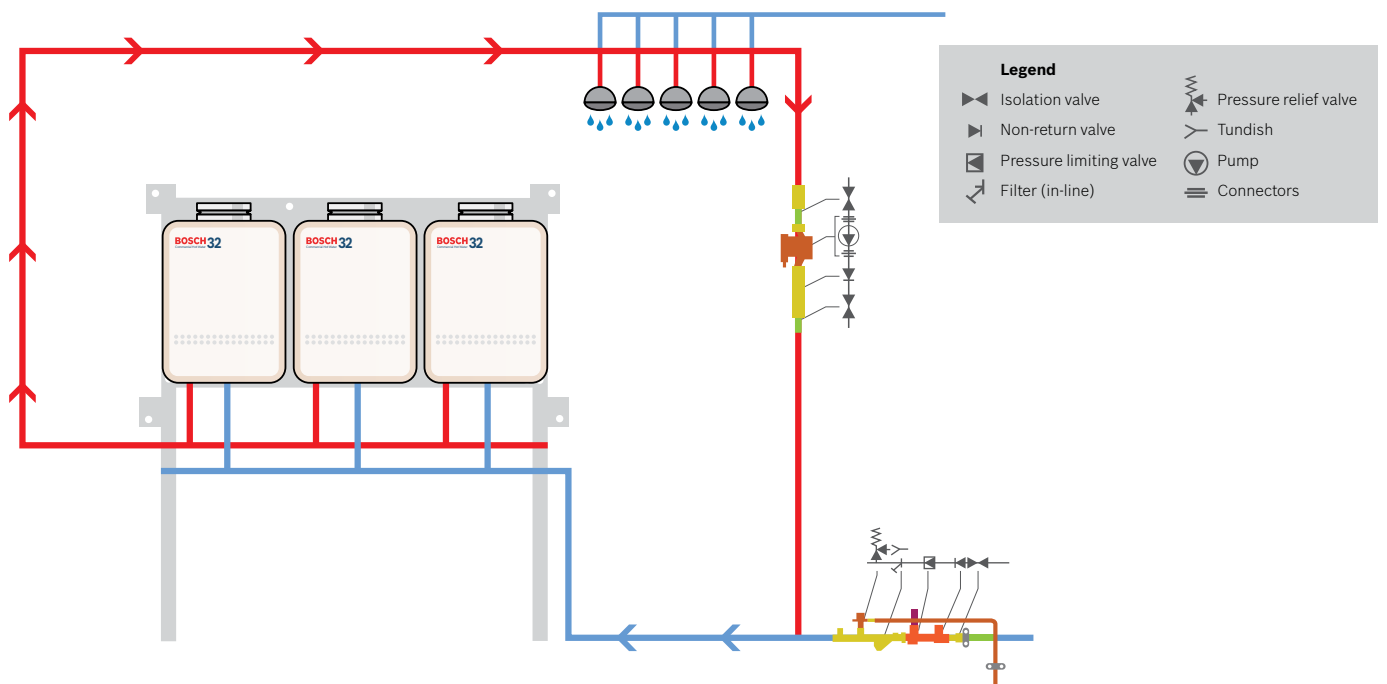

System Layouts

Bosch 32 Water Heater Cascade & Storage Application Layouts

Note: Suitable layout for Bosch 32 & 32C ONLY

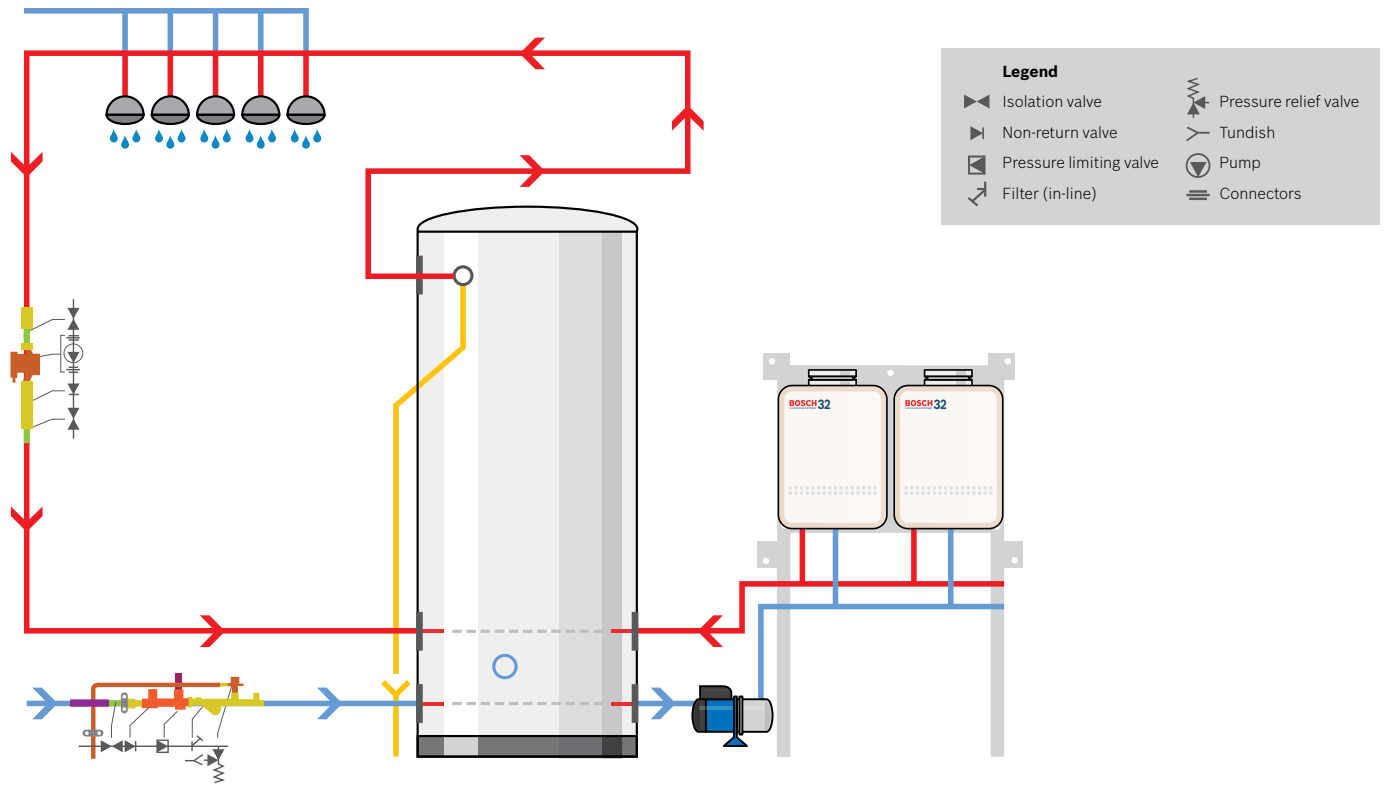

Bosch Commercial 32 Series Accessories

Controllers



Main Remote Controller

Part No: RCM3211

- ▶ Time display
- ▶ Temperature settings
- ▶ “Burner On” display when in use
- ▶ “Circulation mode on” display for 32Q only
- ▶ Full diagnostic display
- ▶ Maximum of 3 controllers can be fitted to the 32, 32Q or 32C. i.e. 1 Main Controller and up to 2 Sub Controllers



Sub Controller

Part No: RCS3211

- ▶ Temperature setting
- ▶ “Burner On” display when in use
- ▶ “Priority” indicator
- ▶ Error display
- ▶ Suitable for 32, 32Q or 32C



Quick Connect Cable

Part No: 0700073

- ▶ Connects any two 32 or 32Cs together
- ▶ Enables staging and rotating functions inbuilt in to 32 or 32Cs
- ▶ Comes standard in 2 appliance manifold packs
- ▶ Only suitable for the 32 or 32C



Systems Controller

Part No: KMSC201

- ▶ Connects three to six 32 or 32Cs together
- ▶ Enables staging and rotating functions inbuilt in to 32 or 32Cs
- ▶ Comes standard in three to six appliance manifold packs
- ▶ Only suitable for the 32 or 32C



Senztek Digital Thermostat

Part No: ALPHASTATPLUSWR

- ▶ Programmable
- ▶ User adjustable water temperature settings
- ▶ Biosafe function for legionella protection
- ▶ High quality, efficiency, reliability and +/-1°C accuracy
- ▶ Sensor diagnostics and smart shutdown
- ▶ Standard with manifold tank kits

Controllers



Vent Cap for Bosch 32 & 32Q

Part No: KMVC-100

- ▶ Used for outdoor installations of the Bosch 32 or 32Q only



Vent Cap for Bosch 32C

Part No: BCVC-100C

- ▶ Used for outdoor installations of the 32C only

Commercial Kit Accessories



Floor Mount Kit

Part No: BFMK32

- ▶ Free standing system for Bosch Cascade Pack
- ▶ Comes standard with Cascade Therm kits



Connection Kit

Part No: BCK32

- ▶ Connects two cascade modules side by side

Bosch Commercial 32 Series Accessories

Secondary Pumps

Dual Star-Z 20/7 Deluxe Pump System

Part No: 8736200002

- ▶ Max head: 7m
- ▶ Connections: ¾" (20mm)
- ▶ Mains AC Voltage: 1 ~ 230V, 50Hz

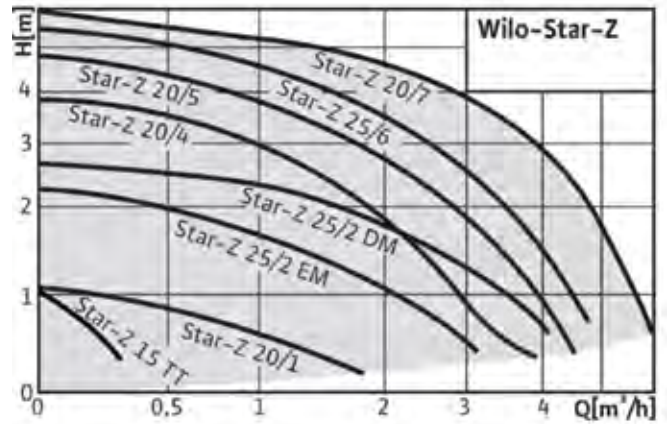

Dual Top-Z 30/10 EM Deluxe Pump System

Part No: 8736200003

- ▶ Max head: 10m
- ▶ Connections: 1 ¼" (32mm)
- ▶ Mains AC Voltage: 1 ~ 230V, 50Hz



Dual Star-Z 20/7 EM Basic Pump Systems

Part No: 8736200004

- ▶ Max head: 7m
- ▶ Connections: ¾" (20mm)
- ▶ Mains AC Voltage: 1 ~ 230V, 50Hz

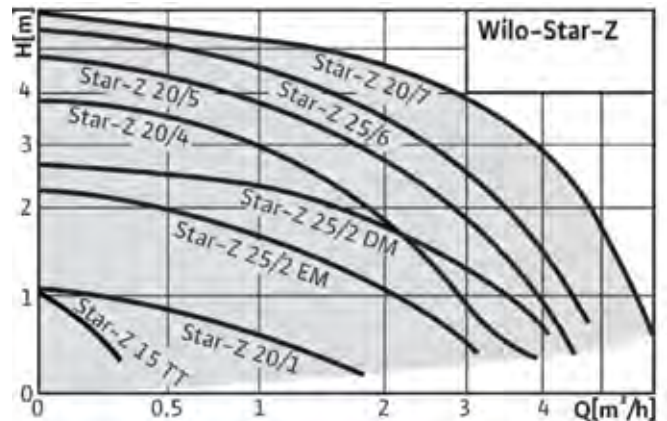

Pump Kit

- ▶ Comes standard in tank packs including two or three cascaded appliances, and a 315L stainless steel tank (refer page 52).
- ▶ Includes Lowara 2HMS3 horizontal multistage pump, thermally wrapped connections and a ball valve.



Pump Kit Technical Information

Lowara 2HMS3

Suitable for drinking water the 2HMS3 is a booster pump within the Bosch tank pack systems.

Technical Information: Lowara 2HMS3

- ▶ Flow rate: 2 m³/h (33.3 L/min)
- ▶ Maximum Head: 20.5m
- ▶ Rated motor power: 30 kW
- ▶ Mains AC voltage: 1~ 220-240V 50Hz
- ▶ Fluid temperature -10°C to 110°C
- ▶ Max operating pressure: 800 kPa
- ▶ Max ambient temperature: 40°C

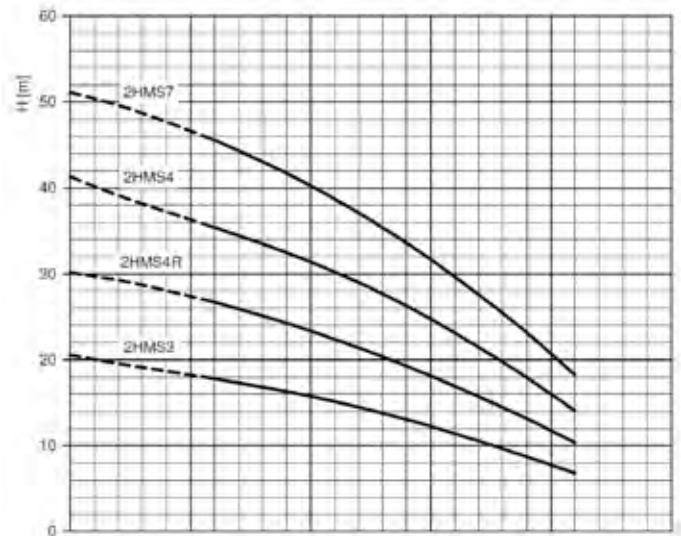

Tanks

315L Stainless Steel Tank - 315C220T

- ▶ 315L Stainless Steel Commercial Storage Tank
- ▶ 20mm flow and return
- ▶ Left hand connections 32mm
- ▶ Sensor well pocket for thermostat
- ▶ Marine grade stainless steel
- ▶ Heat loss exceeds MEPS standards

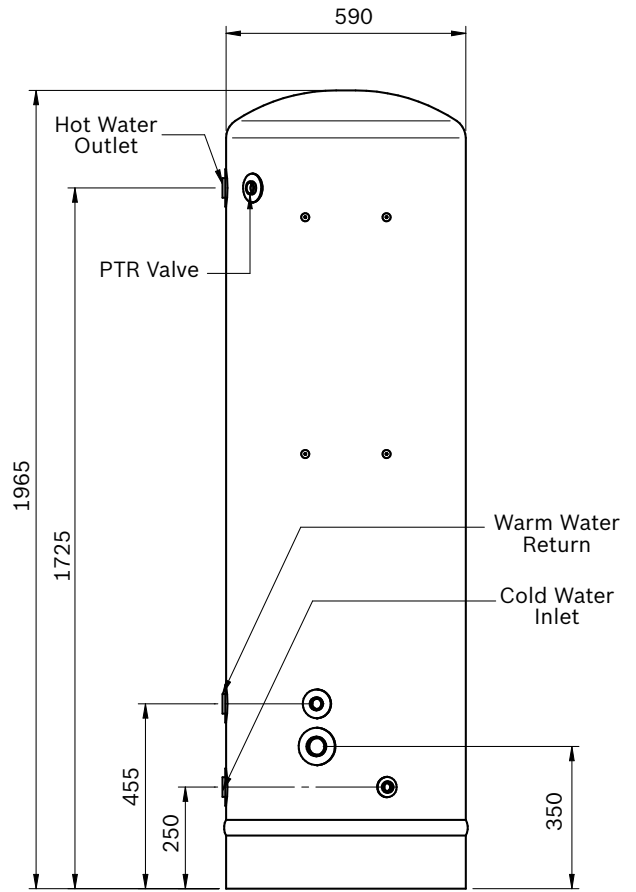
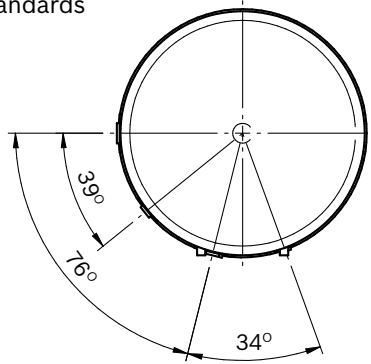

315L Stainless Steel Tank - 315C232LR

- ▶ 315L Stainless Steel Commercial Storage Tank
- ▶ Dual plumbed 32mm left and right hand connections
- ▶ Sensor well pocket for thermostat
- ▶ Marine grade stainless steel
- ▶ Heat loss exceeds MEPS standards

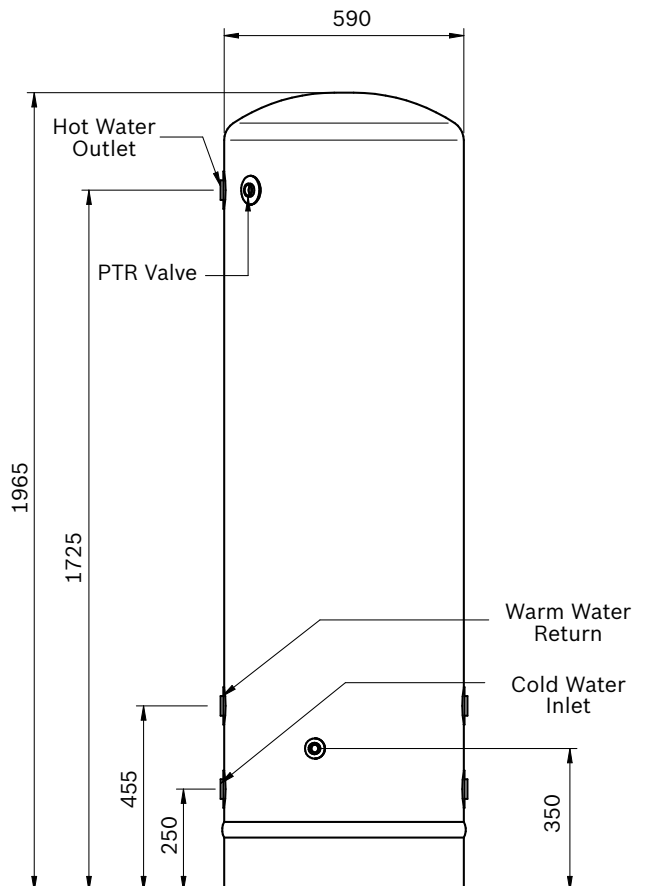
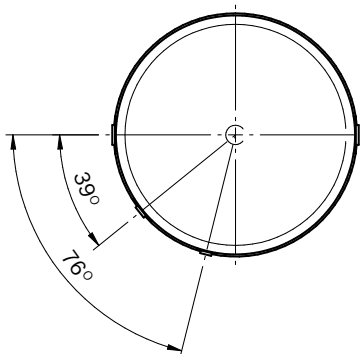

315L Stainless Steel Tank - 315C250T

- ▶ 315L Stainless Steel Commercial Storage Tank
- ▶ 50mm connections with a return line port
- ▶ Sensor well pocket for thermostat
- ▶ Marine grade stainless steel
- ▶ Heat loss exceeds MEPS standards

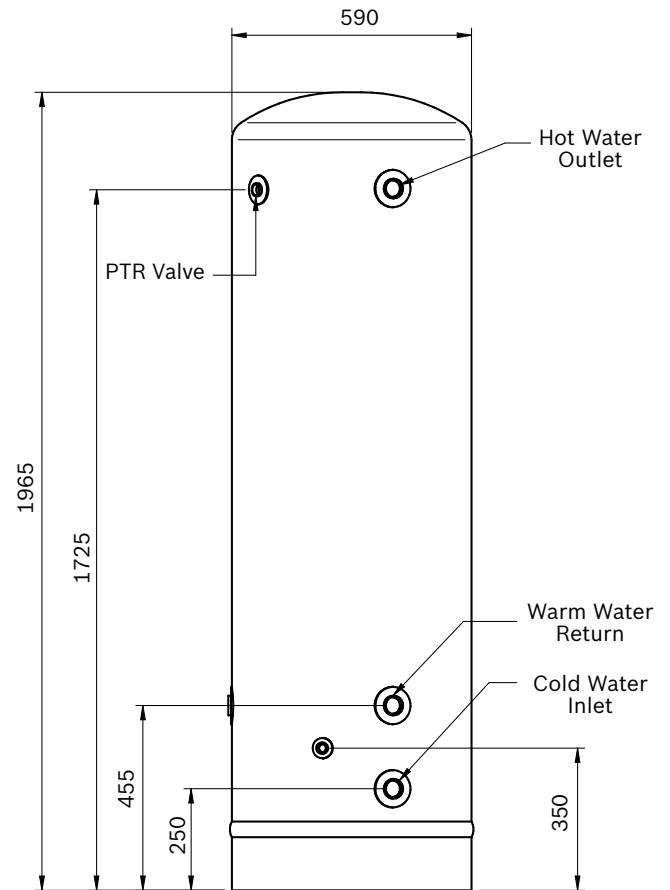
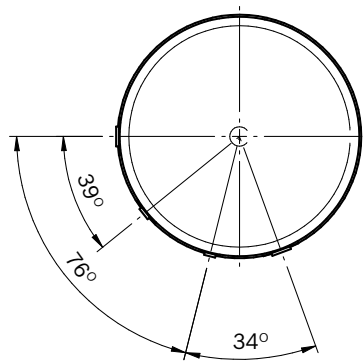

450L Vitreous Enamel Tank - 450VE32T

- ▶ 450L Vitreous Enamel Lined Tank
- ▶ Dual plumbed 32mm left and right hand connections
- ▶ Sensor well pocket for thermostat

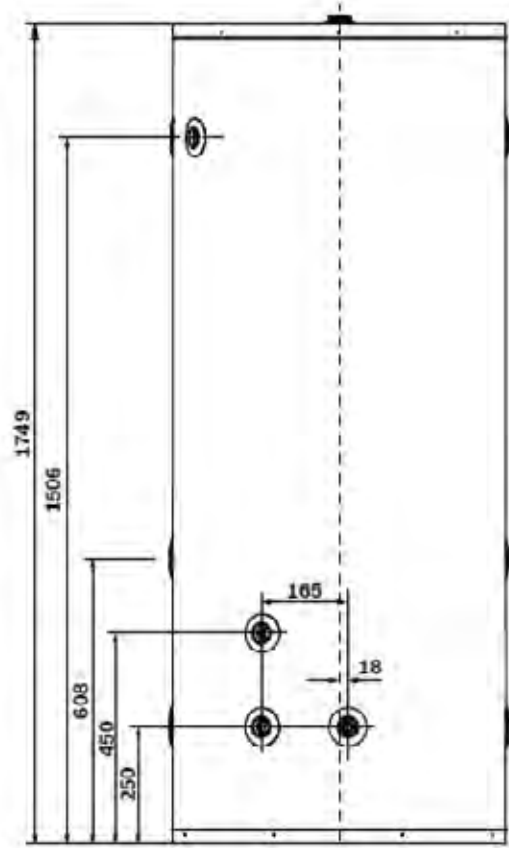
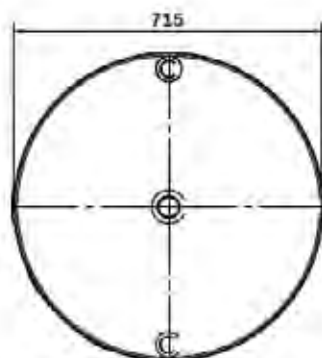

CascadeFlow

Cascade systems



System Application

Bosch cascaded continuous flow systems are designed for applications where high flow rates are required consistently throughout the day. Cascading the systems allows higher flow rates than a single appliance can supply. Intelligent system controls enable staging and rotating which extends the lifetime of the appliances. Commonly installed in sporting clubs, restaurants, commercial kitchens, and laundries, cafes, pubs and hotels.

Available Options

- ▶ NG or LPG
- ▶ Bosch 32 high efficiency, or Bosch 32C appliances available
- ▶ 50°C locked options (Bosch 32C options only)
- ▶ Available in configurations of 2 to 6 appliances

How are they supplied?

- ▶ Fully assembled and mounted on a cascade framework
- ▶ Hot and cold lines pre-plumbed to each appliance
- ▶ All water connections are insulated
- ▶ Gas supply lines pre-plumbed to each appliance
- ▶ All water and gas lines tested to AS/NZS standards
- ▶ Supplied in modules of 2 or 3 cascaded appliances
- ▶ When 4 or more appliances are required, the appropriate combination of modules, connection kits and controllers will be supplied

Included in the pack

- ▶ Bosch 32 or 32C appliance
- ▶ Cascade framework
- ▶ Pipework and fittings
- ▶ Quick connect cord and main controller (2 appliance system), or system controller and cables (3 to 6 appliance systems)

What is required at installation?

As all pipework to the appliances has been sealed and tested, only the following is required by the installing plumber

- ▶ Connection of the two modules (if 4 to 6 appliance options are required)
- ▶ Installation of the floor mount kit (floor standing applications only)
- ▶ Connection to the main hot, cold and gas lines
- ▶ Connection to electricity supply via the two modules
- ▶ Connection and programming of the controller
- ▶ Fit vent cap (outdoor applications) or flue (indoor applications) as required

Product Features

- ▶ Flexible modular design allowing easy pre-plumbed installation
- ▶ electronic staging and rotation system for extended life of the system
- ▶ No gas consumption when hot water is not in use
- ▶ Consistent outlet temperature, even when the flow rate varies
- ▶ Flexible installation as both indoor and outdoor installations are possible
- ▶ Can be used in standard or recirculation installations (additional pump and control system required)
- ▶ Controller available for easy diagnostics
- ▶ Shipped in a heavy duty wooden crate designed for protection during shipping, and safe onsite craning

CascadeFlow Systems

Wall Mounted

Bosch CascadeFlow – CF232W & CF232WC

Part Numbers: CF232WNG, CF232WLP, CF232WCNG, CF232WC5NG, CF232WC5LP, CF232WC5LP

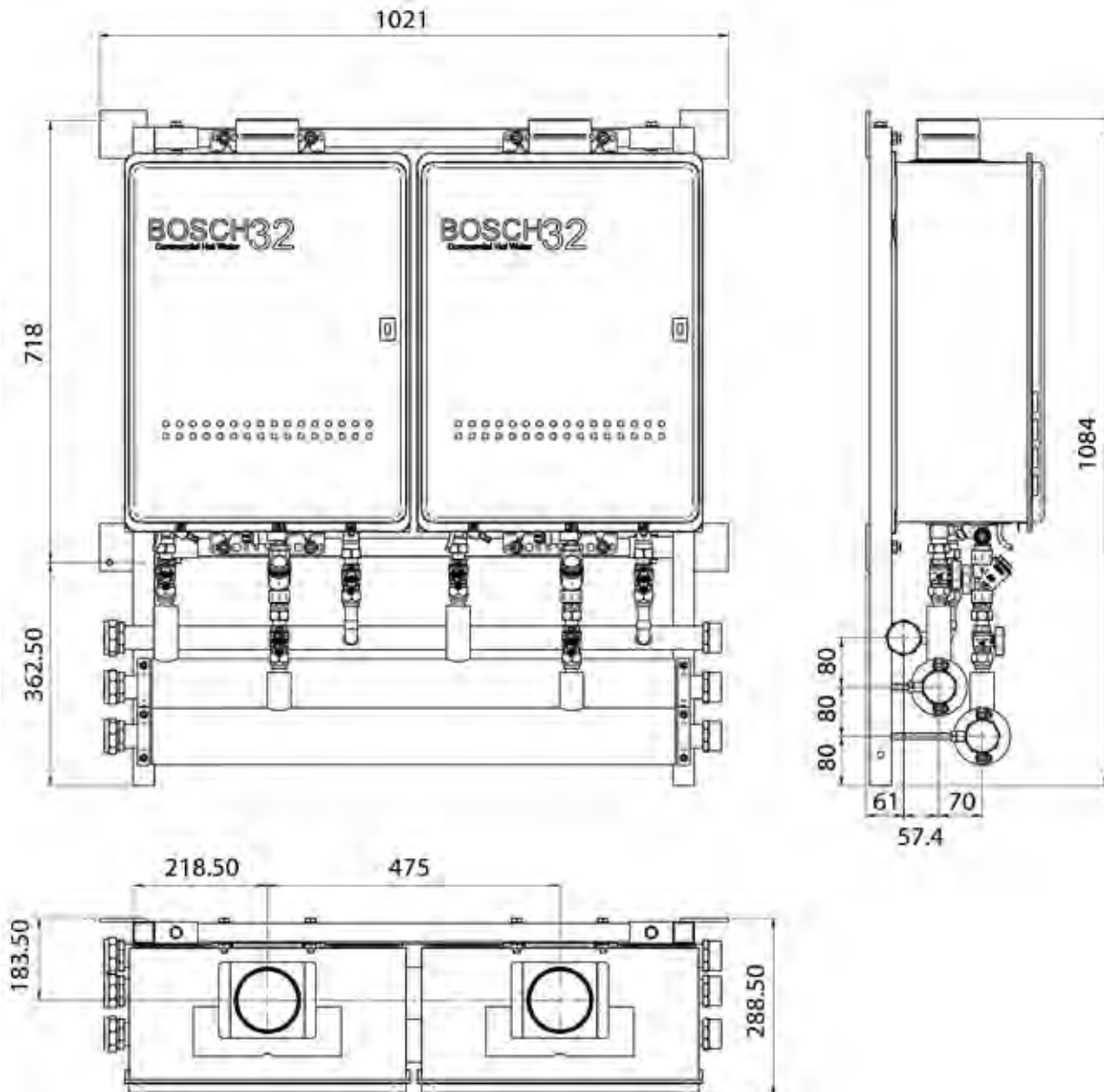

| Specification | Value |
|-------------------------------|----------------------|
| Application | Indoor/Outdoor |
| Thermal Output | 115kW(32C) 111kW(32) |
| Min Gas Supply Pressure (kPa) | 1.13(NG) 2.75(LPG) |
| Gas Input Mj/Hr | 434(32C) 500(32) |
| Litres per minute (25°C Rise) | 64 |
| Litres per minute (50°C Rise) | 32 |
| Hot, Cold and Gas Conn. | 40mm |
| Water Pressure (min) | 200 kPa |
| Water Pressure (max) | 900 kPa |

CascadeFlow Systems

Wall Mounted

Bosch CascadeFlow – CF332W & CF332WC

Part Numbers: CF332WNG, CF332WLP, CF332WCNG, CF332WC5NG CF332WCLP, CF332WC5LP

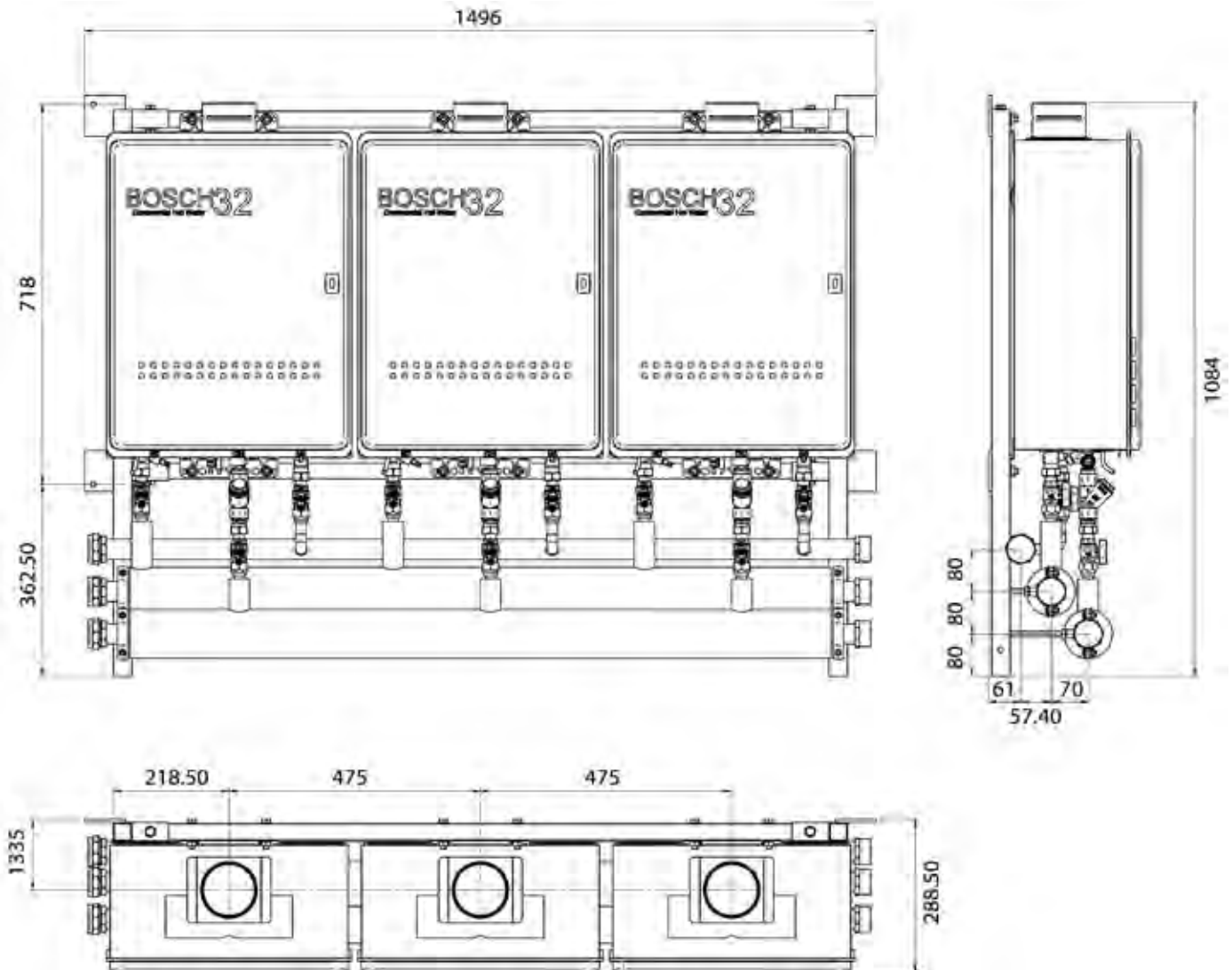

| Specification | Value |
|-------------------------------|------------------------|
| Application | Indoor/Outdoor |
| Thermal Output | 172.5kW(32C) 165kW(32) |
| Min Gas Supply Pressure (kPa) | 1.13(NG) 2.75(LPG) |
| Gas Input Mj/Hr | 651(32C) 750(32) |
| Litres per minute (25°C Rise) | 96 |
| Litres per minute (50°C Rise) | 48 |
| Hot, Cold and Gas Conn. | 40mm |
| Water Pressure (min) | 200 kPa |
| Water Pressure (max) | 900 kPa |

Bosch CascadeFlow – CF432W & CF432WC

Part Numbers: CF432WNG, CF432WLP, CF432WCNG, CF432WC5NG, CF432WC5LP, CF432WC5LP

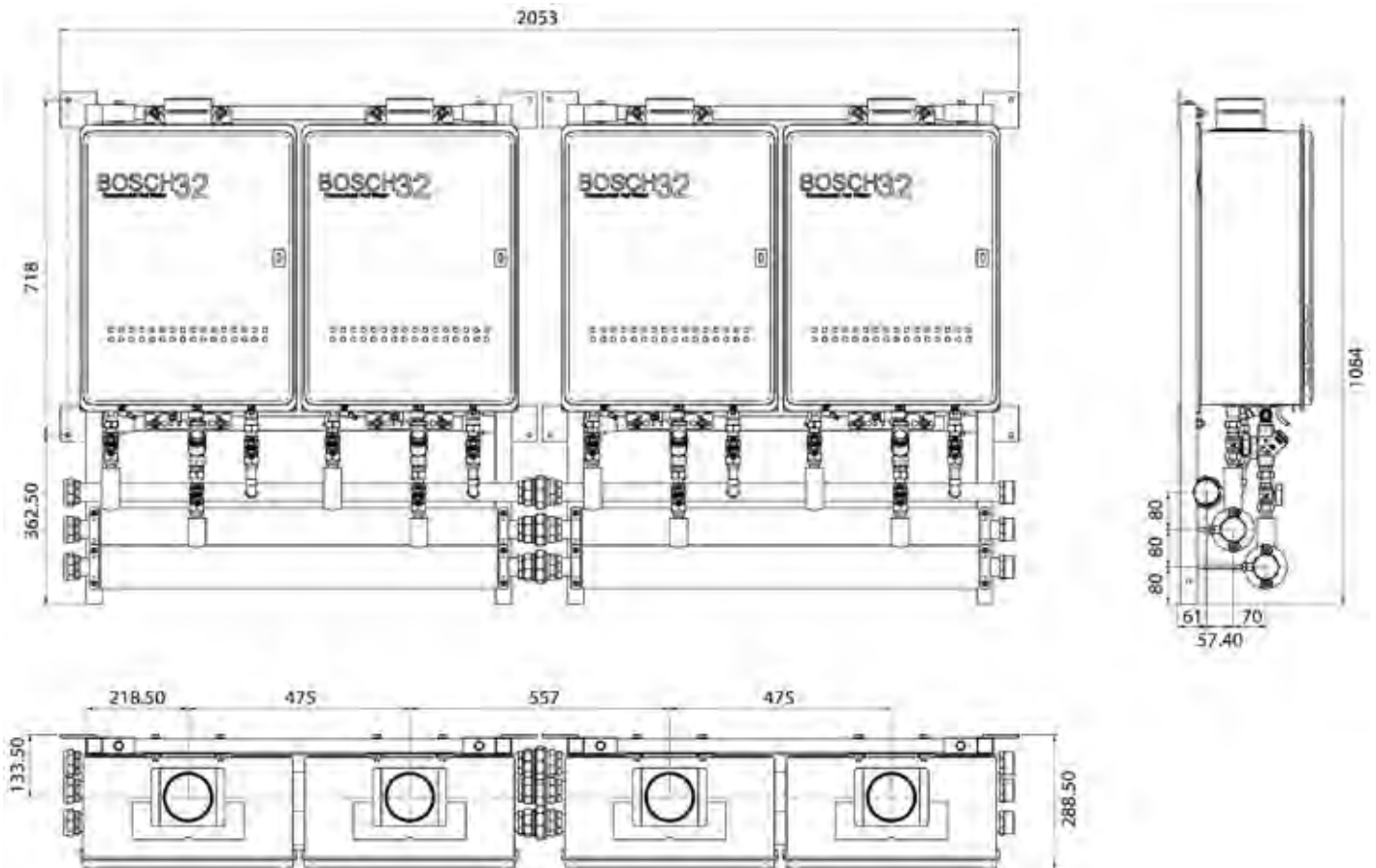

| Specification | Value |
|-------------------------------|----------------------|
| Application | Indoor/Outdoor |
| Thermal Output | 230kW(32C) 220kW(32) |
| Min Gas Supply Pressure (kPa) | 1.13(NG) 2.75(LPG) |
| Gas Input Mj/Hr | 868 32C) 1000(32) |
| Litres per minute (25°C Rise) | 128 |
| Litres per minute (50°C Rise) | 64 |
| Hot, Cold and Gas Conn. | 40mm |
| Water Pressure (min) | 200 kPa |
| Water Pressure (max) | 900 kPa |

CascadeFlow Systems

Wall Mounted

Bosch CascadeFlow – CF532W & CF532WC

Part Numbers: CF532WNG, CF532WLP, CF532WCNG, CF532WC5NG, CF532WCLP, CF532WC5LP

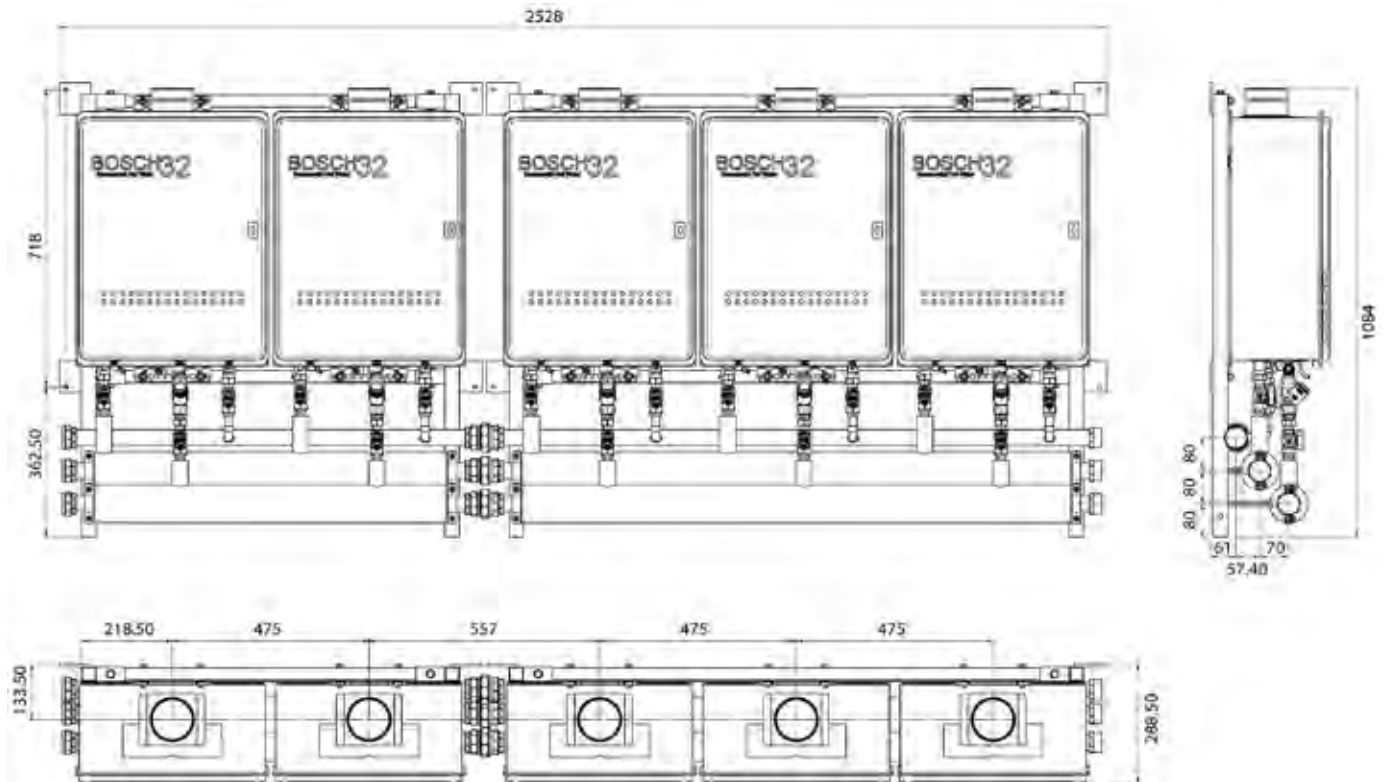

| Specification | Value |
|-------------------------------|------------------------|
| Application | Indoor/Outdoor |
| Thermal Output | 287.5kW(32C) 275kW(32) |
| Min Gas Supply Pressure (kPa) | 1.13(NG) 2.75(LPG) |
| Gas Input Mj/Hr | 1085(32C) 1250(32) |
| Litres per minute (25°C Rise) | 160 |
| Litres per minute (50°C Rise) | 80 |
| Hot, Cold and Gas Conn. | 40mm |
| Water Pressure (min) | 200 kPa |
| Water Pressure (max) | 900 kPa |

Bosch CascadeFlow – CF632W & CF632WC

Part Numbers: CF632WNG, CF632WLP, CF632WCNG, CF632WC5NG, CF632WCLP, CF632WC5LP

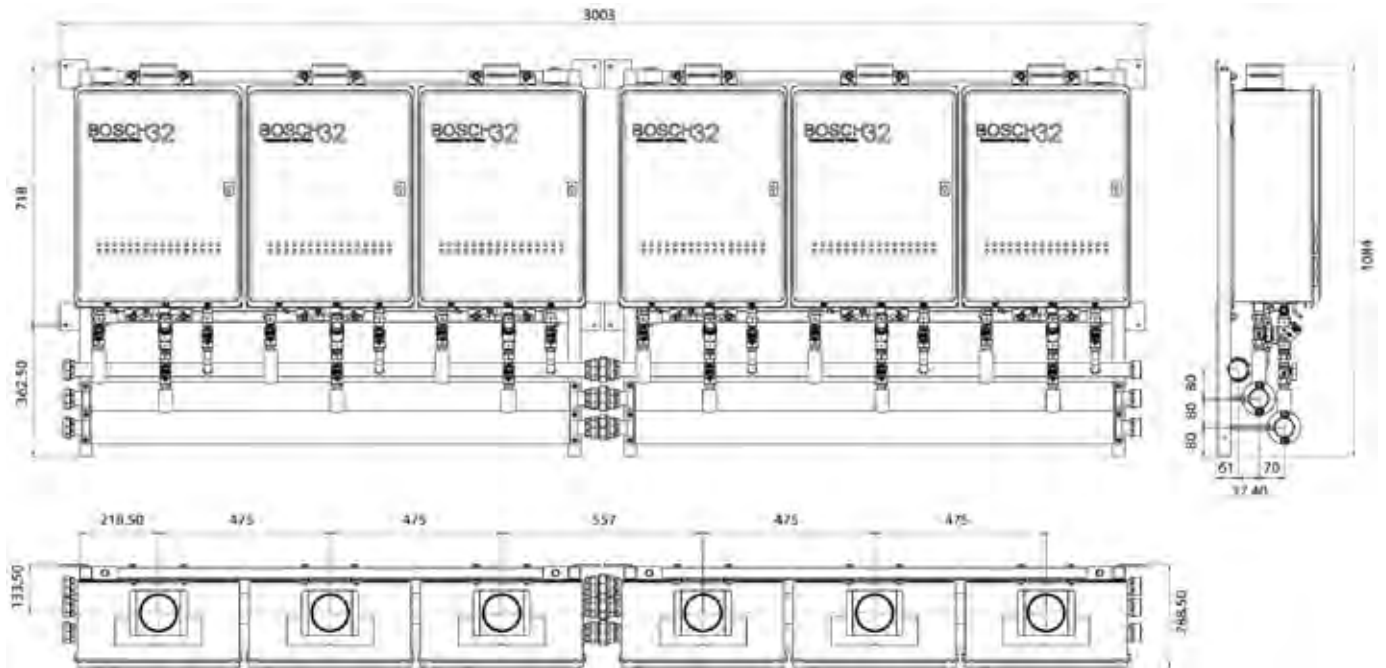

| Specification | Value |
|-------------------------------|------------------------|
| Application | Indoor/Outdoor |
| Thermal Output | 287.5kW(32C) 275kW(32) |
| Min Gas Supply Pressure (kPa) | 1.13(NG) 2.75(LPG) |
| Gas Input Mj/Hr | 1302(32C) 1500(32) |
| Litres per minute (25°C Rise) | 192 |
| Litres per minute (50°C Rise) | 96 |
| Hot, Cold and Gas Conn. | 40mm |
| Water Pressure (min) | 200 kPa |
| Water Pressure (max) | 900 kPa |

Bosch CascadeFlow – CF332F & CF332FC

Part Numbers: CF332FNG, CF332FLP, CF332FCNG, CF332FC5NG, CF332FCLP, CF332FC5LP

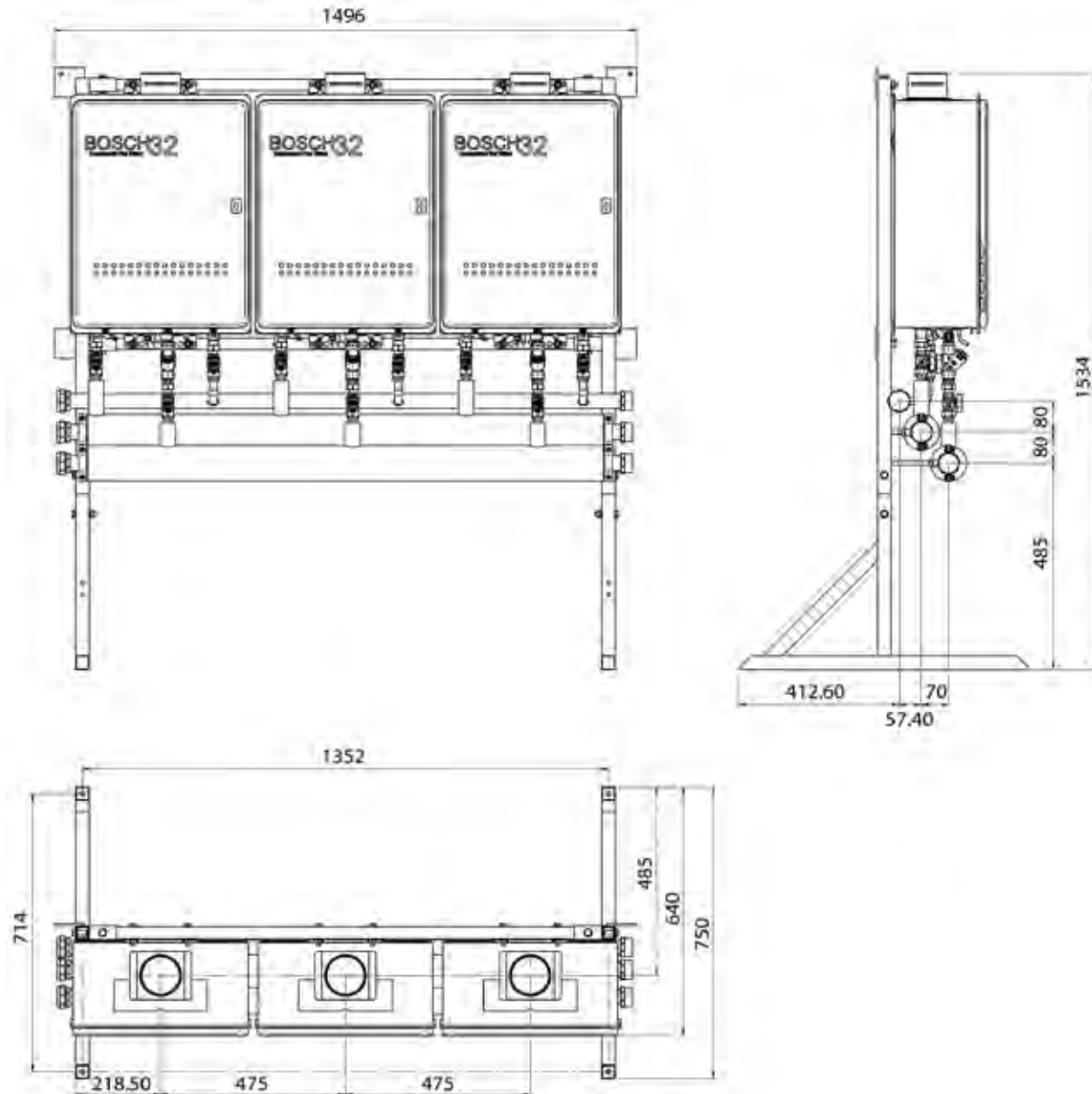

| Specification | Value |
|-------------------------------|------------------------|
| Application | Indoor/Outdoor |
| Thermal Output | 172.5kW(32C) 165kW(32) |
| Min Gas Supply Pressure (kPa) | 1.13(NG) 2.75(LPG) |
| Gas Input Mj/Hr | 651(32C) 750(32) |
| Litres per minute (25°C Rise) | 96 |
| Litres per minute (50°C Rise) | 48 |
| Hot, Cold and Gas Conn. | 40mm |
| Water Pressure (min) | 200 kPa |
| Water Pressure (max) | 900 kPa |

CascadeFlow Systems

Floor Standing

Bosch CascadeFlow – CF432F & CF432FC

Part Numbers: CF432FNG, CF432FLP, CF432FCNG, CF432FC5NG, CF432FCLP, CF432CF5LP

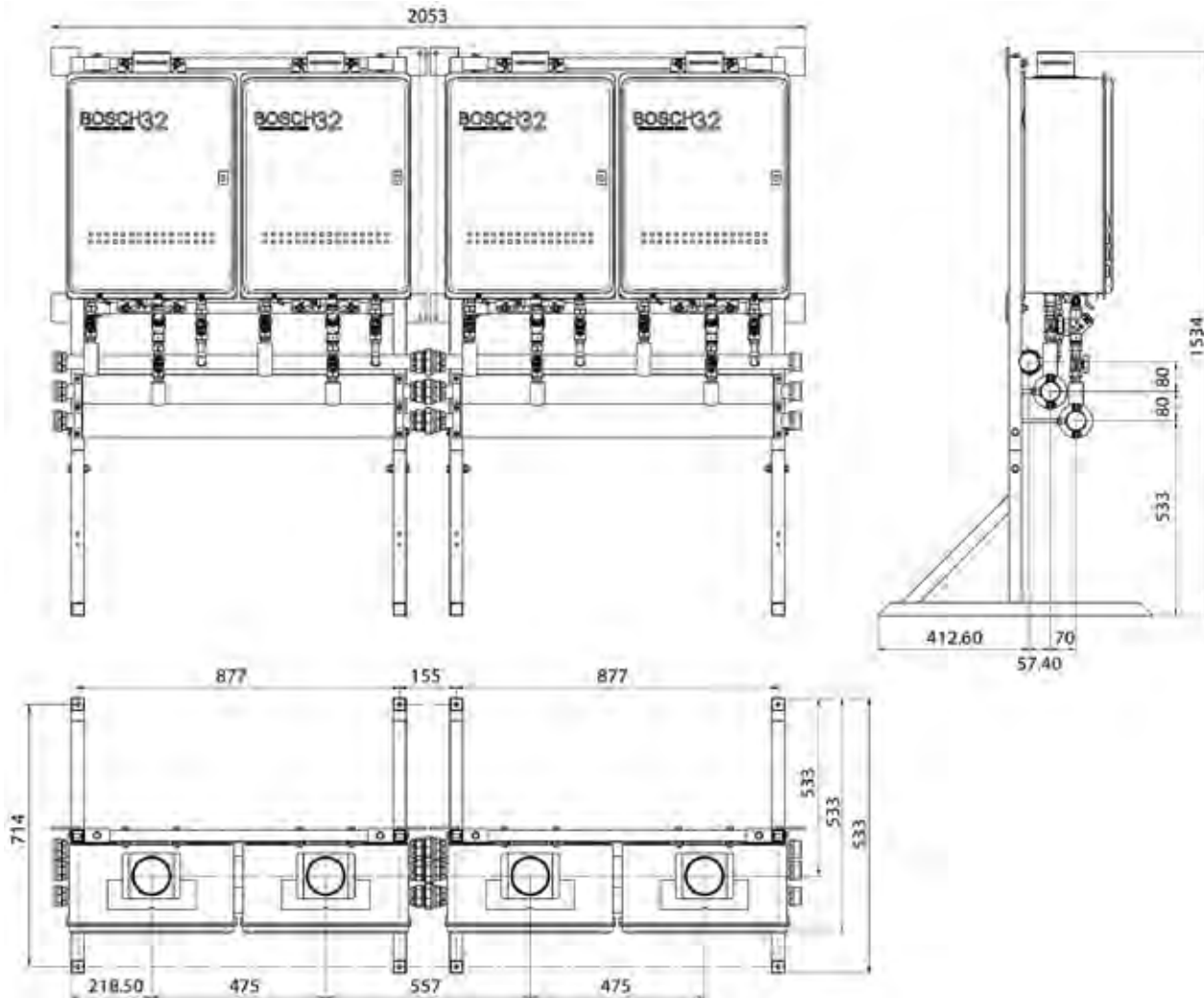

| Specification | Value |
|-------------------------------|----------------------|
| Application | Indoor/Outdoor |
| Thermal Output | 230kW(32C) 220kW(32) |
| Min Gas Supply Pressure (kPa) | 1.13(NG) 2.75(LPG) |
| Gas Input MJ/Hr | 868 (32C) 1000(32) |
| Litres per minute (25°C Rise) | 128 |
| Litres per minute (50°C Rise) | 64 |
| Hot, Cold and Gas Conn. | 40mm |
| Water Pressure (min) | 200 kPa |
| Water Pressure (max) | 900 kPa |

Bosch CascadeFlow – CF532F & CF532FC

Part Numbers: CF532FNG, CF532FLP, CF532FCNG, CF532FC5NG, CF532FCLP, CF532FC5LP

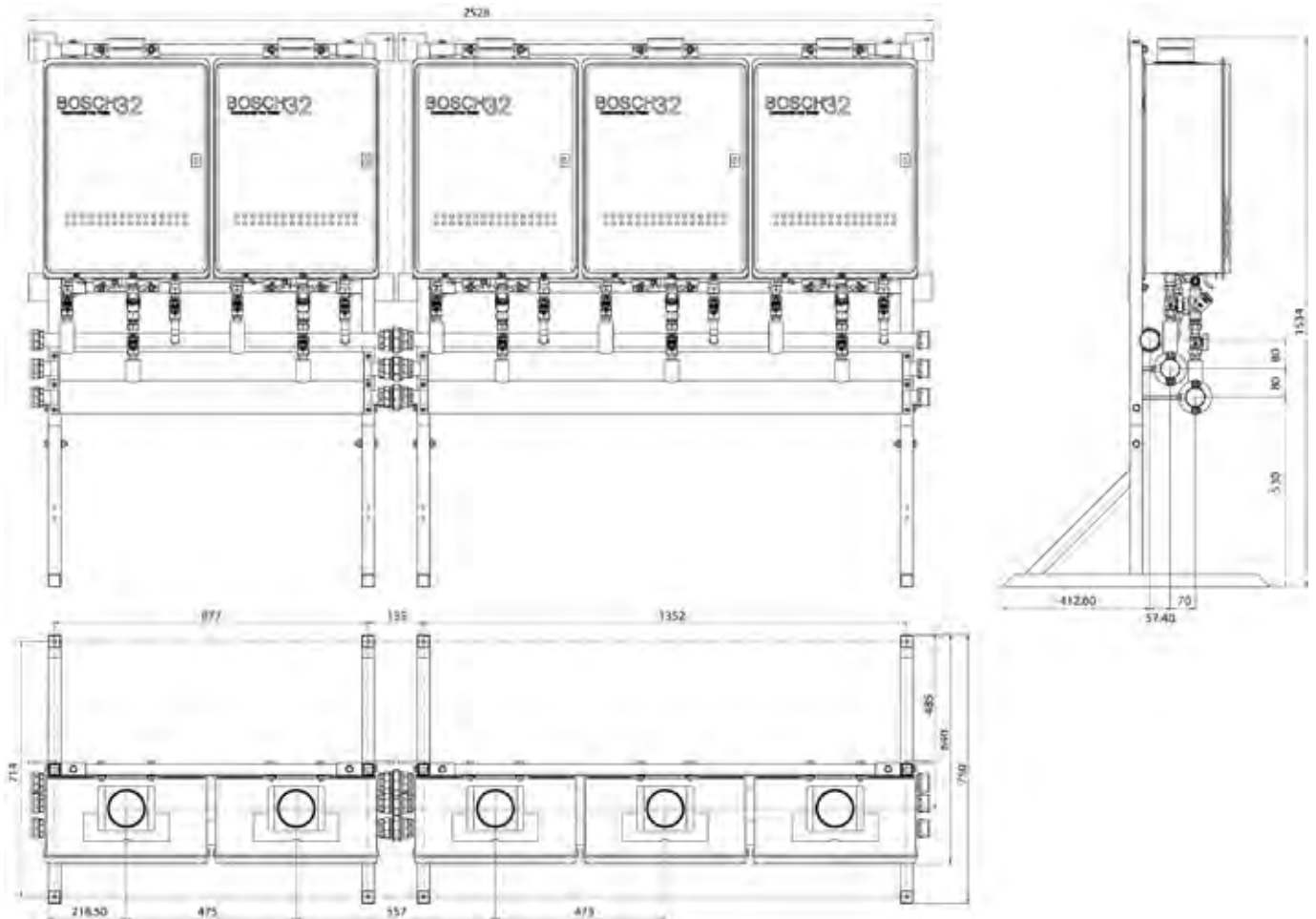

| Specification | Value |
|-------------------------------|------------------------|
| Application | Indoor/Outdoor |
| Thermal Output | 287.5kW(32C) 275kW(32) |
| Min Gas Supply Pressure (kPa) | 1.13(NG) 2.75(LPG) |
| Gas Input MJ/Hr | 651(32C) 750(32) |
| Litres per minute (25°C Rise) | 96 |
| Litres per minute (50°C Rise) | 48 |
| Hot, Cold and Gas Conn. | 40mm |
| Water Pressure (min) | 200 kPa |
| Water Pressure (max) | 900 kPa |

CascadeFlow Systems

Floor Standing

Bosch CascadeFlow – CF632F & CF632FC

Part Numbers: CF632FNG, CF632FLP, CF632FCNG, CF632FC5NG, CF632FCLP, CF632FC5LP

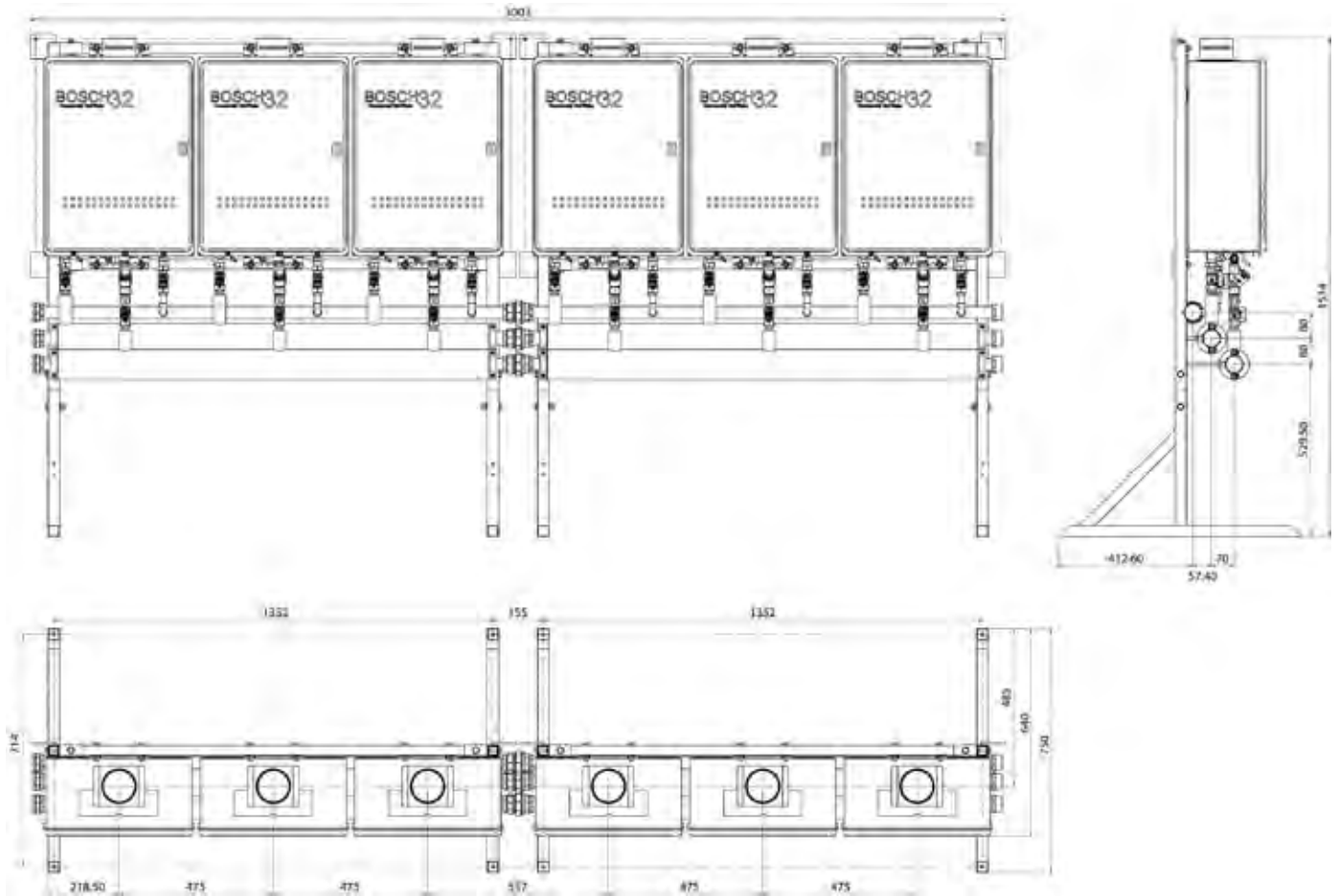

| Specification | Value |
|-------------------------------|----------------------|
| Application | Indoor/Outdoor |
| Thermal Output | 345kW(32C) 330kW(32) |
| Min Gas Supply Pressure (kPa) | 1.13(NG) 2.75(LPG) |
| Gas Input Mj/Hr | 1302(32C) 1500(32) |
| Litres per minute (25°C Rise) | 192 |
| Litres per minute (50°C Rise) | 96 |
| Hot, Cold and Gas Conn. | 40mm |
| Water Pressure (min) | 200 kPa |
| Water Pressure (max) | 900 kPa |

Sizing Guide

CascadeFlow Systems

| Part Number | No of water heaters | Gas rate (Mj/H) | L/min (20°C rise) | L/min (25°C rise) | L/min (50°C rise) |
|--|---------------------|-----------------|-------------------|-------------------|-------------------|
| CF232WNG CF232WLP CF232FNG CF232FLP | 2 x 250 | 500 | 74 | 64 | 32 |
| CF232WCNG CF232WC5LP CF232WC5NG CF232FCNG CF232FC5LP CF232FC5NG | 2 x 217 | 434 | 74 | 64 | 32 |
| CF332WNG CF332WLP CF332FNG CF332FLP | 3 x 250 | 750 | 111 | 96 | 48 |
| CF332WCNG CF332WC5LP CF332WC5NG CF332FCNG CF332FC5LP CF332FC5NG | 3 x 217 | 651 | 111 | 96 | 48 |
| CF432WNG CF432WLP CF432FNG CF432FLP | 4 x 250 | 1000 | 148 | 128 | 64 |
| CF432WCNG CF432WC5LP CF432WC5NG CF432FCNG CF432FC5LP CF432FC5NG | 4 x 217 | 868 | 148 | 128 | 64 |
| CF532WNG CF532WLP CF532FNG CF532FLP | 5 x 250 | 1250 | 185 | 160 | 80 |
| CF532WCNG CF532WC5LP CF532WC5NG CF532FCNG CF532FC5LP CF532FC5NG | 5 x 217 | 1085 | 185 | 160 | 80 |
| CF632WNG CF632WLP CF632FNG CF632FLP | 6 x 250 | 1500 | 222 | 192 | 96 |
| CF632WCNG CF632WC5LP CF632WC5NG CF632FCNG CF632FC5LP CF632FC5NG | 6 x 217 | 1302 | 222 | 192 | 96 |

CascadeTherm

Single appliance pack



System Applications

Ideal for a small commercial applications where consistent hot water volumes are required at certain times of day, or where peaks in hot water demand are frequent.

Available Options

- ▶ NG or LPG
- ▶ Only available with Bosch 32
- ▶ 315L stainless steel tank

How are they supplied?

- ▶ Supplied pre-assembled
- ▶ Shipped in cardboard packaging and strapped to a pallet

Included in pack

- ▶ 315L stainless steel tank
- ▶ Bosch continuous flow hot water appliance. Bosch 32
- ▶ Circulating pump pump
- ▶ Digital thermostat
- ▶ Shroud

Installation requirements

- ▶ Connect the hot and cold water lines, and the gas line
- ▶ Connection to electricity supply via GPOs
- ▶ Connection and programming of the controller
- ▶ Fit vent cap (outdoor applications) or flue (indoor applications) as required

Product Features

- ▶ Up to 1275 litres at 50°C rise in the first hour
- ▶ Ease of maintenance
- ▶ Simple installation as product is pre-assembled
- ▶ Flexible installation as both indoor and outdoor installations are possible
- ▶ Packaged in a wooden crate
- ▶ Accurate temperature control through use of digital thermostat

Bosch CascadeTherm – C315T32WH

Part Numbers: C315T32WHNG, C315T32WHLP

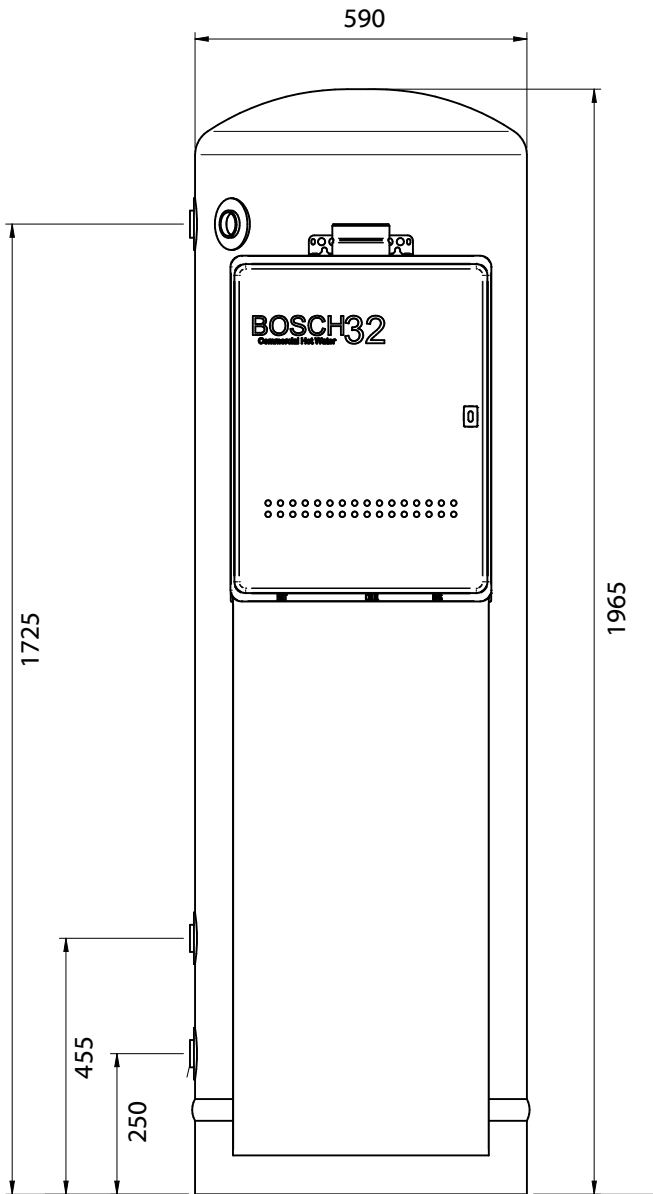

| Specification | Value |
|------------------------------------|----------------------|
| Application | Indoor/Outdoor |
| Thermal Output | 55kW(32) |
| Min Gas Supply Pressure (kPa) | 1.13(NG) 2.75(LPG) |
| Gas Input Mj/Hr | 250(32) |
| Tank material | 316L Stainless Steel |
| Tank Size | 315L |
| First Hour Delivery (50°C Rise) | 1275 |
| Recovery Hour Delivery (50°C Rise) | 960 |
| Hot & Cold Conn. | 32mm |
| Maximum Inlet Pressure (kPa) | 500 |

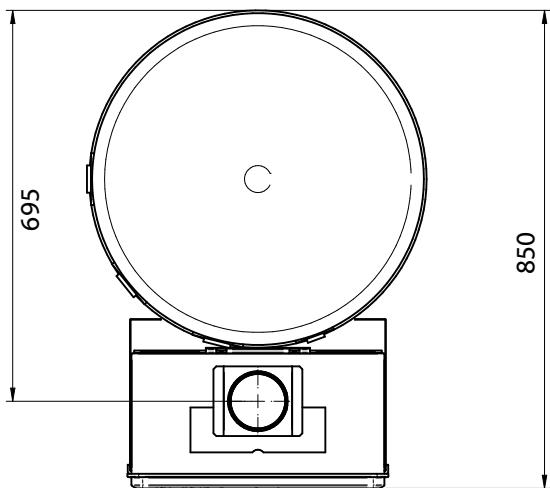

CascadeTherm

Cascade & Tank Systems

System Applications

Used in medium to large commercial applications where hot water requirements peak at certain times of the day. Commonly used in large apartment buildings, hotels, and hospitals.

Available Options

- ▶ NG and LPG
- ▶ Only available with Bosch 32
- ▶ 315L stainless steel tank
- ▶ 2 and 3 appliance options available

How are they supplied?

Cascade modules

- ▶ Fully assembled and mounted on the cascade framework.
- ▶ Hot, cold and gas lines pre-plumbed to each appliance. All water connections are insulated
- ▶ Supplied in modules of 2 or 3 cascaded appliances
- ▶ Supplied with all required controllers, and connection kits
- ▶ Shipped in a heavy duty wooden crate designed for protection during shipping, and safe onsite craning

Tanks

- ▶ Packaged in a wooden crate

Pump kit

- ▶ Pump and connections shipped in a separate carton

What is required at installation?

- ▶ Connection of cascade module to tank via pump connection kit
- ▶ Connection of main hot and cold water lines
- ▶ Connection of main gas line
- ▶ Connection to electricity supply via GPO's
- ▶ Installation of the floor mount kit (floor standing applications only)
- ▶ Connection and programming of the controller
- ▶ Fit vent cap (outdoor applications) or flue (indoor applications) as required

Product Features

- ▶ Up to 3,195L at 50°C rise in the first hour (3 appliance module)
- ▶ Flexible modular design allowing easy pre-plumbed installation
- ▶ Flexible installation as both indoor and outdoor installations are possible
- ▶ Space saving, centralized system
- ▶ Can be used in standard or recirculation installations (additional pump required)
- ▶ Accurate temperature control through use of digital thermostat
- ▶ System controller for easy diagnostics

Bosch CascadeTherm – CT232-1315SS & CT232C-1315SS.

Part Numbers: CT232-1315SSNG, CT232-1315SSLP, CT232C-1315SSNG, CT232C-1315SSLP

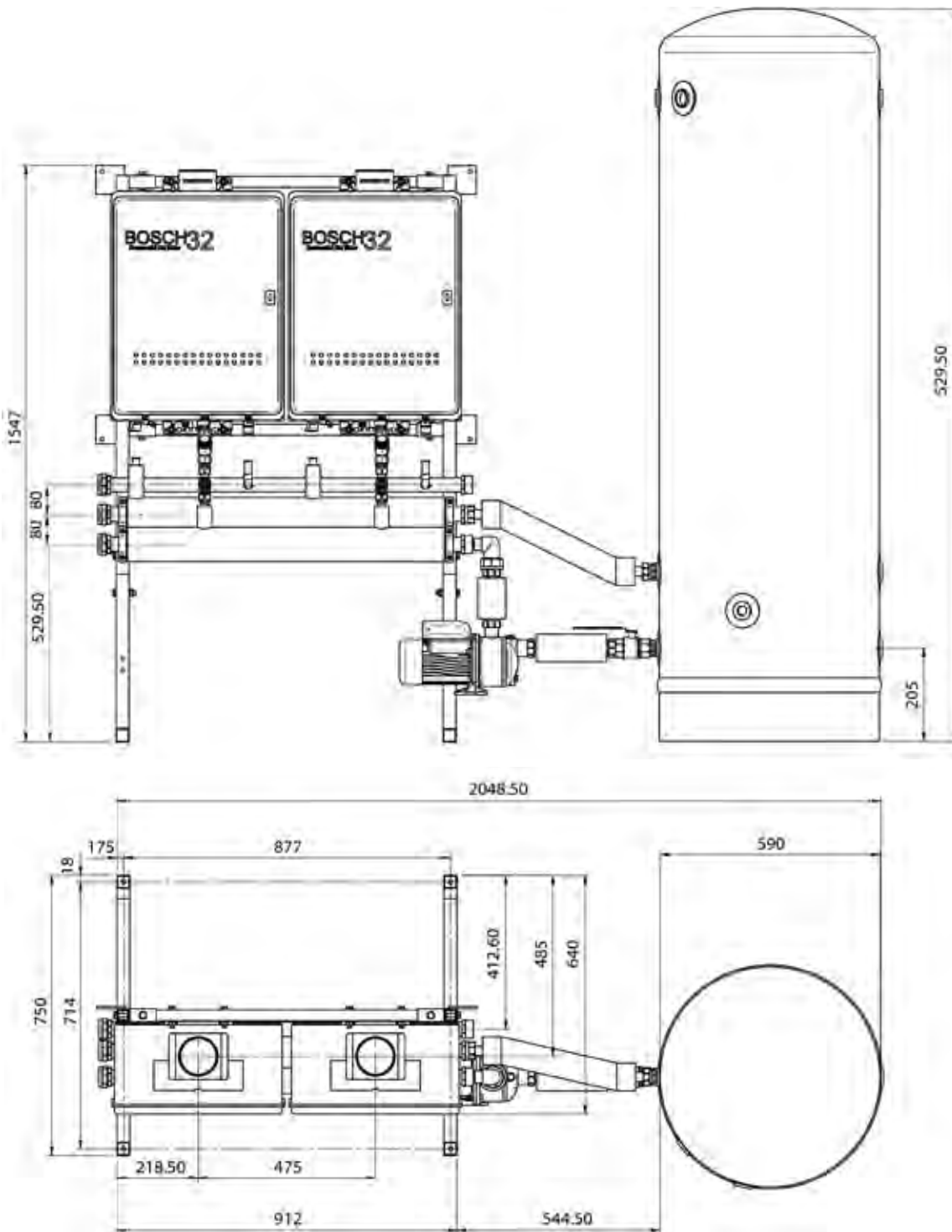

| Specification | Value |
|-------------------------------|----------------------|
| Application | Indoor/Outdoor |
| Thermal Output | 115kW(32C) 110kW(32) |
| Min Gas Supply Pressure (kPa) | 1.13(NG) 2.75(LPG) |
| Gas Input Mj/Hr | 434(32C) 500(32) |
| Tank material | 316L Stainless Steel |
| Tank Size | 315L |

| Specification | Value |
|------------------------------------|---------|
| First Hour Delivery (50°C Rise) | 2235 |
| Recovery Hour Delivery (50°C Rise) | 1920 |
| Hot & Cold Conn. | 32mm |
| Water Pressure (min) | 200 kPa |
| Water Pressure (max) | 500 kPa |

CascadeTherm

Single appliance pack

Bosch CascadeTherm – CT332-1315SS & CT332C-1315SS

Part Numbers: CT332-1315SSNG, CT332-1315SSLP, CT332C-1315SSNG, CT332C-1315SSLP

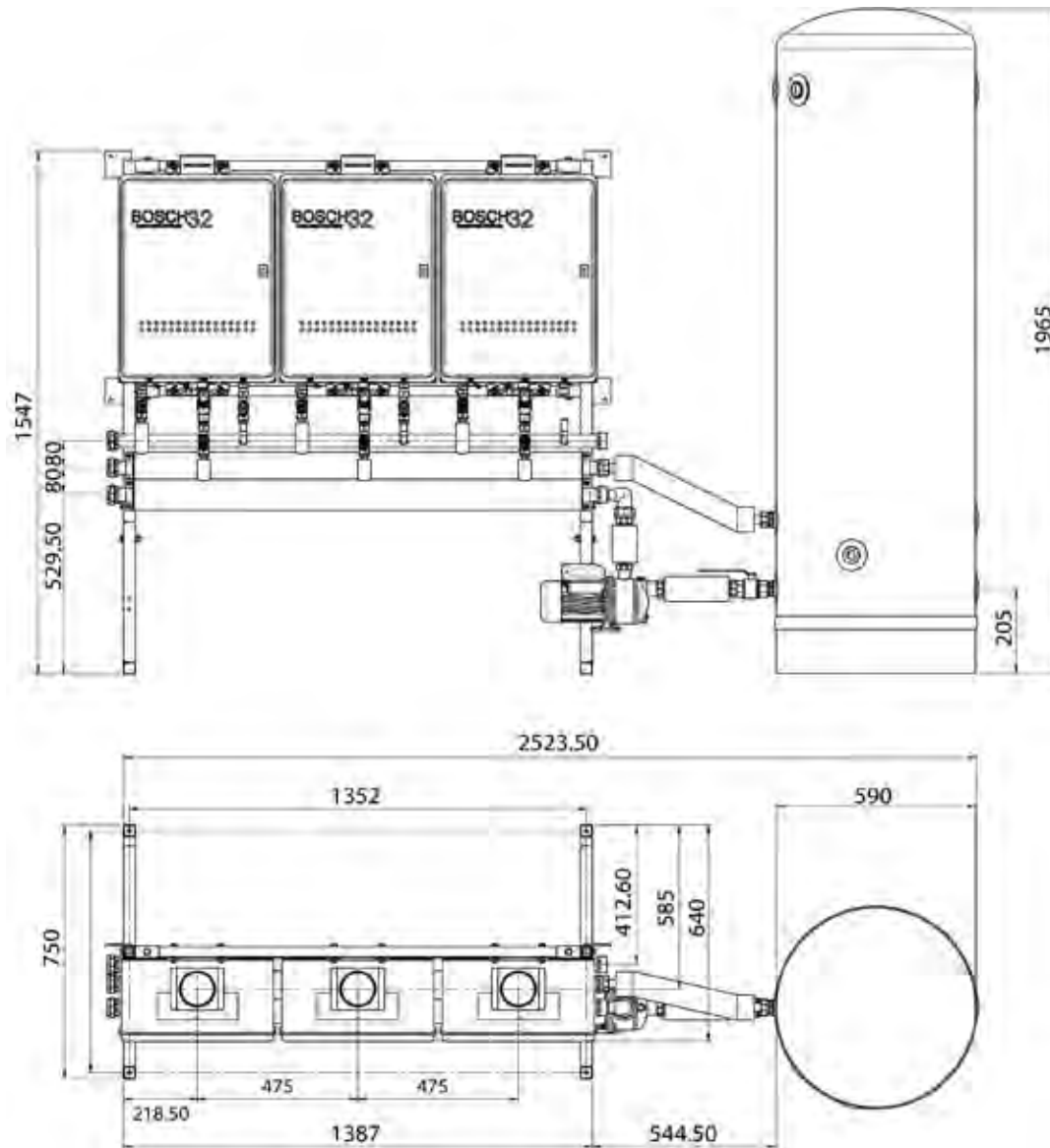

| Specification | Value |
|------------------------------------|------------------------|
| Application | Indoor/Outdoor |
| Thermal Output | 172.5kW(32C) 165kW(32) |
| Min Gas Supply Pressure (kPa) | 1.13(NG) 2.75(LPG) |
| Gas Input Mj/Hr | 651(32C) 750(32) |
| Tank material | 316L Stainless Steel |
| Tank Size | 315L |
| First Hour Delivery (50°C Rise) | 3195 |
| Recovery Hour Delivery (50°C Rise) | 2880 |
| Hot & Cold Conn. | 32mm |
| Water Pressure (min) | 200 kPa |
| Water Pressure (max) | 500 kPa |

Sizing Guide

CascadeTherm Tank Systems

| Part Number | C315T32WH | CT232-1315SS | CT232C-1315SS | CT332-1315SS | CT332C-1315SS |
|---|----------------|----------------|----------------|----------------|----------------|
| No of water heaters | 1 x 250 (Mj/H) | 2 x 250 (Mj/H) | 2 x 217 (Mj/H) | 3 x 250 (Mj/H) | 3 x 217 (Mj/H) |
| First Hour Litres (50°C rise) | 1275 | 2235 | 2235 | 3195 | 3195 |
| Recovery Litres (50°C rise) | 960 | 1920 | 1920 | 2880 | 2880 |
| Tank Size (L) | 1 x 315 | 1 x 315 | 1 x 315 | 1 x 315 | 1 x 315 |
| Gas rate (Mj/H) | 250 | 500 | 434 | 750 | 651 |
| Apartments mix of 1 & 2 bedroom | 20 | 35 | 35 | 50 | 50 |
| Apartments mix of 2 & 3 bedroom | 14 | 25 | 25 | 35 | 35 |
| Hotel Beds 1-3 star rated | 58 | 101 | 101 | 145 | 145 |
| Hotel Beds 4-5 star rated | 36 | 63 | 63 | 91 | 91 |
| Amenities No of (AAA) 3 star showers | 8 | 11 | 11 | 19 | 19 |

Bosch 32 Series and Accessories



Bosch 32C

Part No: BC3200RANG
Part No: BC3200RALP
Part No: BC3200RA5NG
Part No: BC3200RA5LP



Bosch 32

Part No: KM3211WHNG
Part No: KM3211WHLP



Bosch 32Q

Part No: KM3211WHQNG
Part No: KM3211WHQLP



Main Remote Controller

Part No: RCM3211



Sub Controller

Part No: RCS3211



Quick Connect Cable

Part No: 0700073



Systems Controller

Part No: KMSC201



Senztek Digital Controller

Part No: ALPHASTATPLUSWR



Floor Standing Kit

Part No: BFMK32



Connection Kit

Part No: BCK32



Commercial Pump Kit
Part No: BCPK32



Dual Star-Z 20/7 Deluxe Pump
Part No: 873620002



Dual Top-Z 30/10 EM Deluxe
Part No: 873620003



Dual Star-Z 20/7 EM Basic
Part No: 8736200004



Storage Tank Stainless Steel 315L
Part No: 315C220T



Storage Tank Stainless Steel 315L
Part No: 315C232LR



Storage Tank Stainless Steel 315L
Part No: 315C250T



Storage Tank Vitreous Enamel 400L
Part No: 450VE32T



32C PP Extension Pipe 100x600mm
Part No: MG85176



32C PP Extension Pipe 100x1000mm Part No: MG85177



32C PP Flue Elbow 90°
Part No: MG85181



32C PP Flue Elbow 45°
Part No: MG85182



32C Flue Wall Bracket
Part No: MG84631



32C PP Horizontal Wall Terminal
Part No: MG87930



32C PP Vertical Roof Terminal
Part No: MG84862



32C Flue Sealing Ring
Part No: MG27356



Vent Cap for Bosch 32 & 32Q
Part No: KMVC-100



Vent Cap for Bosch 32C
Part No: BCVC-100C



Standard Vertical Flue Kit
Part No:FKV32LTR



Standard Horizontal Flue Kit
Part No: FKH32LTR



Tech & Spec Warranties

| | Parts | Labour | Heat Exchanger | Tanks |
|--|---------|---------|----------------|---------|
| Commercial Appliances | 2 Years | 2 Years | 5 Years | – |
| Tanks | 1 Year | 1 Year | – | 5 Years |
| Flue systems | 1 Year | 1 Year | – | – |
| Pumps | 1 Year | 1 Year | – | – |
| Controllers | 1 Year | 1 Year | – | – |
| Cascade components and Pipework | 1 Year | 1 Year | – | – |

Warranty Statement

A full copy of the Bosch Warranty Statement is available on our websites:

Australia www.bosch-climate.com.au

New Zealand www.bosch-climate.co.nz

Alternatively contact our Customer Contact Centre on 1300 30 70 37 in Australia or 0800 54 33 52 in New Zealand.

Servicing

To ensure your appliance's quality and performance is optimised, Bosch recommends servicing commercial systems no less than once every 2 years. Having your product inspected and cleaned periodically by an authorised Bosch service technician not only ensures peak operation but also extends the life of the appliance.

For contact details of your nearest service agent please phone our Customer Contact Centre on 1300 30 70 37 in Australia or 0800 54 33 52 in New Zealand.

Robert Bosch (Australia) Pty. Ltd.

Australia

1555 Centre Road
Clayton Victoria 3168
P (03) 9541 5555
F (03) 9541 5595
Sales Hotline: 1300 30 70 37
Sales Fax: 1300 30 70 38
www.bosch-climate.com.au



New Zealand

Sales Hotline: 0800 54 33 52
Sales Fax: 0800 54 33 55
www.bosch-climate.co.nz

